

*The*

1/6

# SHORTWAVE

*Magazine*

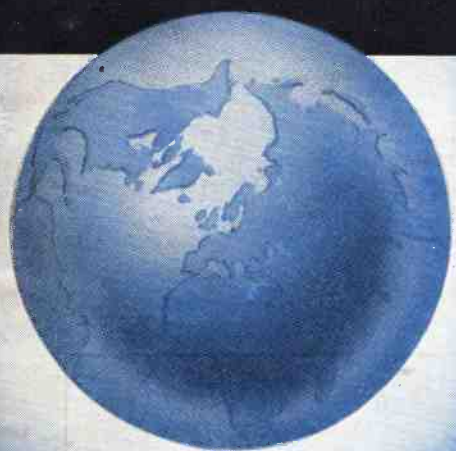

*CW*

**EXCLUSIVELY FOR THE  
RADIO EXPERIMENTER &  
TRANSMITTING AMATEUR**

**VOL. IV No. 11 JANUARY 1947**

# Five & Ten Metre Converter

AS DESCRIBED IN THE CONSTRUCTIONAL ARTICLE IN  
THE EDDYSTONE SHORT WAVE MANUAL

**NOW AVAILABLE FROM STOCK AS AN ASSEMBLED UNIT  
TESTED AND GUARANTEED BY WEBB'S**

*A Frequency Converter that gives really efficient  
results on 5 and 10 Metres*

The converter can be used in conjunction with any good superhet or "straight" receiver, and will improve the ten metre reception of even the finest communication receiver. On five metres tests have shown results equal to specialised high-frequency receivers. The three Mullard Valves were developed during the war for H.F. work and have only recently become commercially available. Service personnel will recognise the EF54 and EC52 as specialised high-frequency valves known previously as the

*Uses Valves : Types R.F. EF54. Mixer—EF50.  
Oscillator—EC52. Recommended I.F. 1.6 mc/s.  
(187.5 metres).*



RL7 and RL16—and this applies also to the EF50.

No power pack is incorporated; an external source of power is necessary, giving 6.3 volts 1 amp. and 200/250 volts 30 milliamps. The main receiver will often provide this small additional power; batteries or a separate pack can be utilised if desired. Actual frequency coverage of converter is 51.4 to 60.5 mc/s and 26.4 to 33.4 mc/s by plug-in coils. Simplicity of coil design makes other interesting H.F. ranges available by experiment.

## FIVE & TEN METRE CONVERTER UNIT

assembled and tested  
(less valves) .. .. £10 10 0

### VALVES

Types EC52 @ 18/3	
EF50 @ 21/4	
EF54 @ 21/4	3 0 11
	<hr/>
	<b>£13 10 11</b>

Available from Immediate Stock.  
The inclusive price of £13/10/11  
includes a copy of the Eddystone  
Short Wave Manual with full  
operating details.

# WEBB'S Radio

14 SOHO STREET, OXFORD STREET, LONDON, W.1

Write, call or Phone : GERRARD 2089. ★ Note our shop hours : 9 a.m.-5.30 p.m. Sats. 9 a.m.-1 p.m.

MIDLANDS CUSTOMERS can draw supplies from WEBB'S RADIO, 41 CARRS LANE, BIRMINGHAM



*Write for pamphlet descriptive of the "AVO" Instruments illustrated above.*

THE world-wide use of "AVO" Electrical Testing Instruments is striking testimony to their outstanding versatility, precision and reliability. In every sphere of electrical test work, they are maintaining the "AVO" reputation for dependable accuracy, which is often used as a standard by which other instruments are judged.

**THE AUTOMATIC COIL WINDER & ELECTRICAL EQUIPMENT CO., LTD.**  
 WINDER HOUSE · DOUGLAS STREET · LONDON · S.W.1 TELEPHONE VICTORIA 3404/B

# SERIES 100 MULTI-RANGE TEST SET by PULLIN

A Service Engineers' instrument, having very low consumption, i.e., 100 Microamps full scale on all voltage ranges A.C. and D.C. Sensitivity 10,000 Ohms per Volt.

The Instrument is housed in a strong metal case with carrying handle and is complete with test leads and prods.

Ranges :—

Milliamps, D.C. only 2.5, 10, 25, 100 and 500. Volts D.C. and A.C. 10, 25, 100, 250, 500 & 1000. Resistance from 100 Ohms to 1 Megohm with 13,500 Ohms at mid scale. Price **£8.10.0.**

**MEASURING INSTRUMENTS (PULLIN) LTD.**

Address all correspondence to :

Dept. T, Phoenix Works, Great West Road, Brentford, Middlesex. Telephone: Ealing 0011



## ELECTRADIX OFFERS!

**METERS.** D.C. Moving Coil micro ammeter, 2" dia., flush panel, 0-500 micro amps, zero adjuster, 500 ohm resistance, 40/-; D.C. Moving Coil milliammeter, 2½" dia., flush panel, 0-1 ma, 55/-; Double reading first grade D.C. Moving Coil Voltmeter, by Elliott, 0-10 and 0-40 volts, 2½", flush panel, 55/-; Ammeters, 0-2.5 amps, 55/-; Hot Wire Ammeters; surplus, panel type, 0-0.5 amps, 21/-; 0-2 amps, 27/6; few only.

**D.C. MOTORS.** Shunt wound K.B.B. Motor, 110 volts 1/100 H.P., protected type, 2,000 r.p.m., with 20/1 ratio reduction gear, mounted on C.I. base, 45/-.

**D.C. Fan Motors;** large bulkhead type, 110 and 220 volts, 35/- each. D.C. 110 and 220 volt Table Fans, with 12" blade and guard, 45/-; oscillator type, 55/-.

**HAND MAGNETO GENERATORS.** Output approximately 70 volts 25 ma A.C., heavy perm steel magnet, wound armature, driven by gearing in handle, for A.C. experiments, 10/-; 3-Magnet type, 12/6; 5-Magnet type, 15/-, postage 1/- extra.

**MOTOR BLOWERS.** 12 volt D.C. for valve cooling and lab. work, 70/-.

**VIBRATORS.** Mallory 12 volt battery Vibrator, 15/-; Special transformer, 27/6; Vibrator Contacts, thin H.F. Reed, bakelite mounted, fine thread adjustment, milled locking nut, 4/-.

**LAMPS.** 230 volt Neon lamps letter plate, E.S. base, 2/6; 25 volt 8 C.P. tubular lamps, S.B.C. base, 7/6 doz.

**SUPERSEDERS.** H.T. Battery Superseder D.C./D.C. for Radio Receivers, 6 volt input, 110 v. 15 m.a. output; 12 volt input, 230 v. 30 m.a. output; last for ever and cost little more than a few months run on one H.T. battery; 5½" x 3½" x 3½", ball bearings, model finish, £3/15/-.

**SWITCHES.** Dewar Key panel switches, 8-pole C.O. flush fitting, 5/-; Yaxley type 8-pole 1-way, 3/6; 3-pole 3-way, 3/6. D.P., C.O. Toggle switches, 250 volts 1 amp, 3/3.

**PLUGS and SOCKETS.** Red and Black insulated, single socket with plug, 1/3 pair. 2-way Radio plug and socket for table mounting, 1/-; 2-pin plug and socket for cord connections, 2/-.

**MULTIPLE CONNECTION STRIPS** of soldering tags, telephone type, moulded mounting, 60-way, 3/6; R. A.F. 10-way telephone terminal strips, bakelite, 2/9.

**HEADPHONES.** Single low resistance headphones, as new, surplus G.P.O. stock type S.G.B., light weight, bakelite case and cap with headband and cord, 8/6. High resistance double headphones, type S.G.B., with headband and cord, light weight, ex surplus, 12/6; new, 23/-.

**CONDENSERS.** Variable 3-gang short wave condensers, new, 12/6; 16 m.mid. Ultra S/W variable air Condensers, ball bearings, Trolitul insulation, new, 5/-; -0003 or -0005 solid dielectric variable Condensers, 3/6.

**COIL ASSEMBLIES.** S/W Midget with trimmer on paxolin base, 3/6; with can, 4/6. Medium and long range Midget Coil, 6/-; matched pair, 10/-.

**PARCELS.** 7 lb. of useful oddsments for your junk box, all clean and dismantled from Government and other surplus apparatus, 7/6, post free.

When ordering, please mention the "S.W.M."

**ELECTRADIX RADIOS**  
214 QUEENSTOWN RD., LONDON, S.W.8  
Telephone MACaulay 2159

# EDDYSTONE AND THE AMATEUR OUR PROGRAMME FOR 1947

As many of you know, we are specialists in the production of Short Wave Equipment of the highest order for the Amateur. In collaboration with several well-known and expert amateurs, we have now designed the outstanding item for 1947—the new "Eddystone" ALL BRITISH Amateur Bands Communication Receiver, Model 640. It is essentially for amateur use and embodying all the desirable features of a first-class communication receiver at a medium price. A brief specification will appear in the February issues of the technical press.

*This is the Set you have been waiting for*

We forecast that this receiver will soon be a by-word among all British amateurs. We are already marketing a comprehensive range of specialized Components, Catalogue of which is available on request. There will be additions to this range from time to time. Another absorbing edition of the Eddystone Manual on less austerity lines is on the way. Keep in touch with your local Eddystone retailer for latest developments.



**STRATTON & Co. Ltd.**  
EDDYSTONE WORKS  
WEST HEATH, BIRMINGHAM, 31



## SWITCHES ARE CONDEMNED

*to Hard Labour for Life—*

**OAK EXCLUSIVE**

**DOUBLE CONTACT**

**SELF-ALIGNMENT**

**ENSURE RELIABILITY**



★ Only genuine when bearing these Patent Nos.—  
478391, 478392, NSF OAK.

# NSF OAK SWITCHES

**BRITISH N.S.F. CO. LTD.**, Head Office and Export Sales: Keighley, Yorkshire

London Office: 9 Stratford Place, W.1. Phone MAYfair 4234.

(Sole Licensees of OAK Manufacturing Co., Chicago)

# UNIVERSAL TAYLORMETER

**Model  
90a**



*First grade accuracy,  
40 ranges, 1000 ohms per volt.*

- 1 Four-inch meter scale.
- 2 Mirror and Knife edge pointer.
- 3 Buzzer for Continuity Tests.
- 4 Automatic overload protection.
- 5 Self-Contained Resistance measurements from 1 Ohm up to 1 Megohm.
- 6 Three Self-contained capacity ranges with external A.C. Supply.

Limited supplies of these instruments are now available. All orders are executed in strict rotation.

Please write for technical brochure.

Price:—  
**£15.15.0.**

Send enquiries to your usual factor or direct to:

## Taylor

**Electrical Instruments Ltd.**

419-424 MONTROSE AVENUE, SLOUGH, BUCKINGHAMSHIRE  
Tel: Slough 21381 (4 lines) Grams: "Taylins" Slough

**THE FINEST CORED SOLDER IN THE WORLD**

## New Large Size

The most economical way in which to buy Ersin Multicore—the solder wire containing 3 cores of non-corrosive Ersin Flux—is in the new large size one carton. Available in 4 specifications. Wire pulls out without becoming tangled.

SIZE ONE CARTON. Service Engineer & Maintenance Size.

Catalogue Ref. No.	Alloy Tin/Lead	S.W.G.	Approx. length per carton	List price per carton (subject)	
				s.	d.
C 16014	60/40	14	58 feet	6	0
C 16018	60/40	18	151 feet	6	9
C 14013	40/60	13	36 feet	4	10
C 14016	40/60	16	83 feet	5	3



Small (Size Two) Cartons. Each carton contains enough Solder for approximately 200 average joints. Price 6d.

**MULTICORE SOLDERS LIMITED**

MELLIER HOUSE, ALBEMARLE STREET, LONDON, W.1. Telephone: REGent 1411



## A Fine Achievement!



in Radio Reception has been attained by the latest S. G. BROWN, Type K

### MOVING COIL HEADPHONES

Where High Fidelity Reproduction is required, such as for DX work, Monitoring and Laboratory purposes, etc., these precision-built Moving Coil Headphones will be highly appreciated.

#### Technical Details:

D.C. RESISTANCE—94 ohms per pair  
 IMPEDANCE—104 ohms @ 1,000 c.p.s.  
 SENSITIVITY—8Dbs. above 1 microwatt per bar @ 1,000 c.p.s.

PRICE £5.5.0 PER PAIR

#### DESCRIPTIVE BROCHURE

"S.W.K." will be sent free on request. For details of other S. G. Brown Headphones (prices from 25/- to 60/-) ask for Brochure "S.W."

## S.G. Brown, Ltd.

VICTORIA RD., NORTH ACTON, LONDON, W.3 'Phone: ACOrn 5021

## Radio Equipment for the Amateur by Radiocraft

We hold in stock a range of high-class equipment, designed to meet the most exacting requirements of the Short Wave Experimenter. For callers we are open from 9 a.m. until 6 p.m., both on weekdays and Saturdays. Our Mail Order Department will give rapid and efficient service to postal enquiries and orders.

Some of the Equipment now in stock—

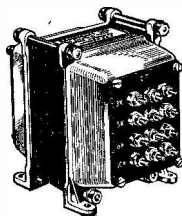

#### MODULATION TRANSFORMERS

Specially made to our design. Compact and fully shrouded. Frequency response ideal for clean crisp speech transmission.  
 60 watt model. Max. Sec. current 175 m/a 45/-  
 100 watt model. Max. Sec. current 250 m/a 65/-

**CHASSIS AND PANELS (STEEL).**—A very nice job. Standard finish, grey crackled enamel. These chassis are zinc plated before enamelling, and the inside faces are not enamelled but left with zinc surface. 17 x 10 x 2", 11s. 6d.  
 Panels to order can be drilled at slight additional charge. Template should be sent showing position and size of holes required. We can also quote for special chassis, panels, etc.

**HEAVY DUTY RESISTORS.**—75 watt rating, with adjustable tap. 25,000 ohms, 11s. 8d., also large range of vitreous enamelled resistors of all types, up to 50,000 ohms.  
 Our complete list will shortly be available. Send 2½d. stamp for a copy.

### CONSTRUCTIONAL SERVICE

We have a staff of highly skilled Radio Engineers, who specialise in the construction of equipment for Amateurs, such as Power Packs, Converters, Audio Amplifiers, and Transmitters. All apparatus is built to a high standard of quality and thoroughly tested. Send us your enquiries, and we will submit quotations.

## Radiocraft Ltd

11 CHURCH ROAD, UPPER NORWOOD  
 LONDON, S.E.19 'Phone: LIVingstone 4787

**NOTE**—We have absolutely no connection with any other firm trading under the same or similar name as ourselves.

## UNSURPASSED for SHORT WAVE WORK



Ericsson Supersensitive Telephones simply annihilate distance. Perfect in tone. Really comfortable in wear. British made. All good dealers 25/- or direct

# Ericsson

**SUPERSENSITIVE  
TELEPHONES.**

56 Kingsway, London, W.C.1

HOLborn 6936

## COILS! COILS! COILS! **AMATEUR RADIO PRODUCTS**

*Adjustable Iron-Cored Coils  
are now available from stock*

### AERIAL—H.F.—OSCILLATOR

The range covers all wavebands.

- 2000 Metres to 800 Metres (Iron Cored)
- 550 Metres to 200 Metres (Iron Cored)
- 206 Metres to 80 Metres (Iron Cored)
- 90 Metres to 33 Metres (Iron Cored)
- 45 Metres to 16 Metres (Iron Cored)
- 25 Metres to 9 Metres (Iron Cored)
- 15 Metres to 4.5 Metres (not iron cored)

ALL AT 3/- EACH

Above ranges also available on standard size paxolin formers,  $1\frac{1}{2}'' \times \frac{3}{8}''$ , in Aerial—H.F.—Oscillator, at 2/6 each.

**CERAMIC TRIMMERS** 30, 50, 70pF, at 1/ each.

**4-WAVE BAND S/W COIL UNIT.** 206 to 9.3 metres. Fully wired and switched; for 2-wave battery-operated receiver, using 160 mmfd. condenser. 30/- complete with circuit.

All orders to Dept. "S.M."

### AMATEUR RADIO PRODUCTS

50 Glassyn Road, Crouch End, London, N.8

Telephone: MOUntview 4745

# LABGEAR

Manufacturers of

## HIGH GRADE COMMUNICATIONS EQUIPMENT

### APPLICATIONS FOR LABGEAR

#### 150 WATT COIL TURRET

This is a highly efficient Coil Turret for modern band switched Transmitters and is the answer to all P.A. coil changing problems. Any one of the 28, 14, 7 and 3.5 mc/s Amateur bands can be selected by the turn of a front panel control, which also automatically selects its own switched low impedance output link for feeding into an antenna matching unit.

Used in conjunction with a standard 50 + 50 pF Split Stator Tuning condenser (such as Labgear Cat.E.5001/A) the two combine to form a complete Multi-band Tank Assembly.

### WILLOW PLACE,

Phone - 2494 (2 lines)

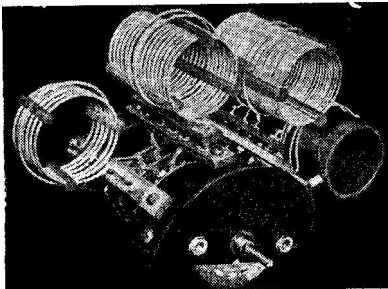

Illustration showing Turret Switch unit with Coils for 28, 14, 7 and 3.5 mc/s operation assembled in position

# LABGEAR

Write now for further details and your copy of our 1947 S.W. Booklet

### CONSTRUCTION OF LABGEAR

#### 150 WATT COIL TURRET

This assembly is built around a heavy duty multi-bank RF switch designed especially for transmitting applications. Particular attention has been paid in design to RF dielectric and contact series resistive loss, providing maximum overall efficiency. The plug-in inductances are ruggedly constructed, the low loss type coils are accurately spaced by moulded radio frequency dielectric. Max. sizes  $10\frac{1}{2}$  in.  $\times$   $6\frac{1}{2}$  in.  $\times$  5 in. Unit complete but less coils. Cat. No. E.5010/A, Coils for 28, 14, 7 and 3.5 mc/s—E.5010 B, /C, /D and /E respectively.

### CAMBRIDGE, ENG

Grams - Labgear, Cambridge

Labgear Transmitting Components are obtainable through most leading component stockists, but if difficulty of supply is encountered please write direct to Sales Dept., Labgear, Willow Place, Cambridge.



## Denco are pleased to announce

that most components can now be supplied from stock, the exceptions being C.T.3 Turrets (12 weeks), C.T.2 Turrets (2 weeks) and certain coil ranges (2 weeks).

We draw your special attention to :—

### INTERMEDIATE FREQUENCY TRANSFORMERS, I.F.T.6

Litz wound coils with adjustable iron dust cores giving a high performance transformer. Designed for 465, 1.6, 3, 5, or 10 Mcs. with all leads brought out from the base (Type A) or with top Grid lead (Type B).

Overall Dimensions 3.5" high  
1.4375" square  
Price : Type A, 8/-  
Type B, 8/6

### I.F.T.7

Miniature Maxi-Q Transformer for 465 Kcs. or 1.6 Mcs.

Litz wire windings with an adjustable pot type core mounted on a polystyrene base. Designed for optimum coupling, and giving a Q equal to 155 for the 465 Kcs. type, and 140 for the 1.6 Mcs. type.

Overall dimensions 2" high  
1" square  
Price : 9/6

### MAXI-Q COILS

High Q miniature sized receiver coils for Aerial, R.F. coupling, R.F. coupling with reaction or superhet oscillator stages. Covering from 170 Kcs. to 130 Mcs. in eight ranges. Designed for chassis mounting or to plug in to standard octal valve holder.

The adjustable iron dust cores and polystyrene formers make these compact and highly efficient coils.

Price : Chassis mounting type, 3/6  
Plug in type, 3/9  
R.F. Coupling with reaction type, 9d. extra.

**DENCO (CLACTON) LTD., OLD ROAD, CLACTON-ON-SEA, ESSEX**



## Q.C.C. TYPE P5 QUARTZ CRYSTAL UNIT

This unit uses the well-known Q.C.C. Power type crystal, which is undoubtedly the most rugged and active crystal cut available for amateur use. The crystal is mounted in our type U dust proof holder, with standard 1/2 in. pin spacing, as illustrated above.

The P5 unit has a temperature co-efficient of 20 cycles per megacycle per degree Centigrade temperature change. Used with a 6V6 or 6L6 type beam tetrode, it will give up to 5 watts r.f. output on the fundamental frequency, and approximately 3 watts on the second harmonic in the Tritet circuit.

Available in the 1.8 to 2.0 Mc. band for fundamental use, and in the 3.5 Mc. band and 7 Mc. band for frequency multiplying to the 28 and 58 Mc. bands.

An official certificate of calibration is sent with each P5 unit, giving the frequency under stated operating conditions to an accuracy of 0.025%.

PRICES : Ground to your specified frequency  
In the above bands ... £1.17.6

Or ground to a frequency not specified by you  
but taken from our stock ... £1.12.6

Please note that all the leading dealers in amateur equipment now carry stocks of the P5 crystal unit.

**THE QUARTZ CRYSTAL CO. LTD.** (Directors: E. A. Dedman, G2NH., N. H. R. Munday, G5MA., W. J. Thompson, G2MR.) 63/71 Kingstons Road, **NEW MALDEN, SURREY.** Telephone : **MALden 0334**

## ★ PUBLIC OPINIONS! ★

Read these extracts from letters requesting a copy of the Candler "Book of Facts."

"I am an absolute beginner, but knowing of the efficacy of the Candler System, I should be glad if you would forward your 'Book of Facts.'" REF. 4158

"I am just a beginner of Morse and I would like to improve. I have heard glowing reports of your system and am very interested." REF. 3662

"Kindly send me details of your 'Scientific Code Course for Beginners.' I know enough of your system and its merits not to require any testimonials." REF. 3660

AND THESE from letters sent us by Candler students.

"I would like to take this opportunity of thanking you, not only for the Course, which I consider to be unbelievable 'value for money,' but also for your kindness and personal attention." REF. 3120, N.H.

"I have successfully passed the P.M.G. amateur's licence test and have been allotted my call sign. I took it with ease, after completing lesson 3."

"I passed the code test to obtain my Amateur licence with flying colours. The Telegraph Inspector wanted to know where I had learnt to do Morse with such precision and co-ordination. I could do nothing but give all the honours to the Candler System. . . . At present I am able to get a good 25 w.p.m. without any faltering. . . . It will always be a pleasure and an honour to recommend the Candler System to anyone who might require it." REF. 2566, P.J.L.

There are Candler Morse Code Courses for **Beginners and Operators.** Write for the Candler "Book of Facts." Free on request.

**THE CANDLER SYSTEM CO. (555.W.)**  
121 Kingsway, London, W.C.2.

Candler System Co., Denver, Colorado, U.S.A.

## SOUTHERN RADIO AND ELECTRICAL SUPPLIES

**WEARITE CERAMIC ROTARY SWITCHES.** Already assembled in single or multi-bank with the following specification per bank:—3-way 4-pole, 6-way 2-pole, 12-way 1-pole. Single bank switches, 13/6; 2-bank, 22/6; 3-bank, 31/6; 4-bank, 39/6.

Individual parts of the above switches can be supplied at standard list prices.

**QUARTZ CRYSTALS.** Q.C.C. P5 in enclosed holder 1.8, 3.5 and 7 Mc bands, 32/6. Hamrad crosscut 7 Mc band 22/6, or 30/- in enclosed holder. Your own specified frequencies 5/- extra. Hamrad enclosed plug-in crystal holder, 9/6.

**HEAVY DUTY PUSH-PULL INPUT TRANSFORMERS.** S712 to feed PX4's, 18/9. S713 to feed 6L6's, 18/9.

**TRANSMITTING VARIABLE CONDENSERS.** Eddystone, 60 plus 60 pF flashover, voltage 2,000 RMS, 54/6; 100 pF flashover, 4,500 v. RMS, 75/-; Cylidon, 100 pF 37/6, 60 + 60 pF 30/-, 100 + 100 pF 37/6, with .082" air gap.

**RECEIVING VARIABLE CONDENSERS.** Eddystone, 20 pF 6/-, 40 pF 6/6 (both types double spaced), 60 pF 7/-, 100 pF 7/11, 160 pF 8/3. Denco, 15 pF 6/3, 25 pF 6/8, 50 pF 7/2, 100 pF 7/9.

**EX-GOVT. HAND MICROPHONES.** Carbon inset type with switch in handle, lead and socket, ideal mike for transmitters, 10/-.

Please include postage on orders under £2. Large 40-page illustrated catalogue of Ham lines, 6d. post free.

85 FISHERTON STREET, SALISBURY, WILTS.

Telephone: Salisbury 2108.

## A.C.S. RADIO

### 1947 PROMISES TO BE A BIG YEAR IN AMATEUR RADIO

WITH thousands of new stations on the air all over the world, your equipment must be efficient and up to the minute to enable you to get the most from your hobby.

WHETHER you are wanting a big receiver or a small component our service is at your disposal. We are enthusiasts ourselves and have first-hand knowledge of Amateur requirements.

OUR Component Catalogue is revised monthly and contains hundreds of items, including Coils, variable and fixed Condensers, Aerial Equipment, Meters, Valves, Chokes, Transformers, Crystals, Speakers, Phones, etc.

IN Communications Receivers we can usually offer a good selection of well-known types such as NATIONAL HRO, NC81X, NC45, RME69, DB20, DM36, HALLICRAFTER SX24, Marine, Dual Diversity. As stocks are continually changing, let us know your requirements and we will endeavour to meet them.

IF you are in the Bromley district, call in for a personal QSO and examine our stocks of EDDYSTONE, RAYMART, HAMRAD and LABGEAR Components, S.T.C. Valves, PULLIN Meters, etc.

**44 WIDMORE RD BROMLEY, KENT**  
Phone RAVensbourne 0156

## Laboratories & U.H.F. Experimenters please Note!

WE OFFER THE W1310 U.H.F. WAVE-METER COVERING THE FREQUENCIES 155-220 Mcs.

This fine and accurate instrument was originally designed for I.F.F. Radar use, and is supplied complete with calibrated chart (individual to every instrument), probe, and fitted wooden case.

This instrument is MAINS OPERATED and is an absorption type with magic eye indicator. A separate oscillator section is provided. Complete with all valves ready for use. Ideal for laboratory use.

AT THE VERY LOW COST OF £8.8/- (carriage and packing, 7/6). (Original manufactured cost over £70.)

We also offer the CONTROL UNIT 39/11 (carriage and packing, 7/6)

Type 439 comprising:—

Metal case with various plugs and paxollin strips.

- 4 5-pin UX (807 type) valveholders amphenol.
- 1 1.0 valveholders amphenol.
- 1 2mfd 750v. block condenser.
- 2 1500 ohm 25w. wire-wound resistor.
- 1 Mains transformer.
- 16 ½w. resistors.
- 2 1w. resistors.
- 2 Potentiometers, wire-wound.
- 8 .05 mfd 350v. tubular condensers.
- 1 .1 mfd 350v. tubular condensers.
- 4 Electrolytic condensers, etc., etc.

WE HAVE AVAILABLE A FEW MORE I.F.F. RADAR R3002 TRANSMITTER RECEIVERS

These comprise a complete transmitter receiver operating between 155-185 Mcs. and easily convertible for amateur use. Complete with 10 valves:—

- 2 of RK34, 1 of EF50, 4 of SP41, and 3 of DI, and also Lucas motor generator 20 watts. (12v. input, 480v. 40 m/a output).

79/6 (carriage 4/-).

Send Stamp for our Illustrated Catalogue.

# M.O.S.

**MAIL ORDER SUPPLY CO.**  
24 NEW ROAD, LONDON, E.1  
STEPNEY GREEN 2760

## "Cydon" Transmitting Capacitors

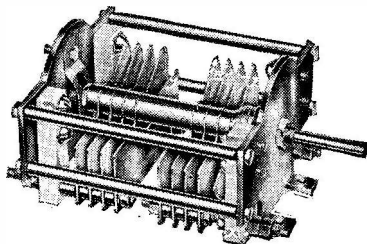

### TYPE TRMSS

Max. Capacity	List Price
30+30 pF.....	£1 : 7 : 6 each
60+60 ,,.....	£1 : 10 : 0 ,,
80+80 ,,.....	£1 : 12 : 0 ,,
100+100,,.....	£1 : 17 : 6 ,,

Air Gap .082 in.

**SYDNEY S. BIRD & SONS, LTD.**

Cambridge Arterial Road, Enfield, Middx.

Phone : ENfield 2071-2 'Grams : "Capacity, Enfield"

## QUARTZ CRYSTALS

All Amateur Bands from **£1 12 6**  
 And usual IF ranges from **£1 12 6**  
 100 Kc/s Reference Unit at **£2 5 0**

Special stabilised reference unit giving extreme accuracy on both 100 and 1000 Kc/s with marker points covering all amateur bands up to high frequencies at £3

Indispensable for checking receivers, signal generators, and transmitters, etc.

## BROOKES CRYSTALS LTD.

(Established 1929)

51/53 GREENWICH CHURCH STREET,  
 GREENWICH, LONDON, S.E.10

Phone : GRE 1828

## LASKY'S RADIO NEW YEAR SPECIAL LIMITED QUANTITY ONLY

**Ex-A.M. H.F. PACKS. NEW. VALUE OVER £3/10/-.** Consisting of: 2 Midget Valves, 1S5 and 1T4; 2 Button Valveholders, Ceramic; approx. 24 assorted, Midget size Condensers and Resistances; Midget Group Boards, Nuts, Bolts, Tags, etc.; Double Potentiometer; Midget 3-way Yaxley type switch 4-pole; Midget Trans.; 1 Trimmer. Price 25/-.

**B.F.O. UNIT.** Consisting of: one midget valve, 1S5 and one midget valveholder, ceramic midget B.F.O. coils resistances and condensers in aluminium can, size  $4\frac{1}{2}'' \times 2\frac{3}{4}'' \times 1\frac{1}{4}''$ . Price 12/6.

Valve Screening Cans, Best Quality, 2/3 each. Midget I.F. Cans "Wearite" 465 kc/s, 10/6 each. Picapack Midget Bias Condensers, the very latest 10 mfd, 25 v.w.; 20 mfd. 12 v.w. (Electrolytic), 2/6 each. 1 mfd. 8,000 v.w. Tubular Condenser, 10/- each. All types of Wearite "P" co.ls, 3/- each.

2 $\frac{1}{2}''$  Black Knobs,  $\frac{1}{4}''$  Spindle, Brass Insert, High Grade, 1/6 each; 15/- per doz.

Systoflex, all sizes and colours from 1/6 per doz. yds.

Metals Xmitter or Amplifier Cabinets, built-in chassis, hinged lid, plated handles, rubber feet, grey crackle finish. Size—height 8", depth 10 $\frac{1}{2}''$ , length 18". Price £4 10 0.

**Ex R.A.F. Resistance and Condenser Panels.** No. 1,  $4\frac{1}{2}'' \times 3''$ . Three 1 mfd, 500 v.w.; Two 5,6000 5 watt Resistances; Four  $\frac{1}{2}$  watt Resistances; wired up with brackets. Value over 7/6.  
 No. 2,  $8'' \times 3''$ . Two 3 watt Resistances; Four 1 watt Resistances; Three  $\frac{1}{2}$  watt Resistances; One .005 mfd. 1,000 v.w. Condenser; One Diode holder. Price:—No. 1, 2/6; No. 2, 2/6; Limited Quantity Only.

**MIDGET VOLUME CONTROLS.** 5500,  $\frac{1}{2}$  meg, and 1 meg less switch, 2/11 each.

### Just Arrived

4 mfd. Oil Filled Condensers, 800 v.w. With fixing feet. Price 5/9 each. 600 v.w. 4/9 each. Full range of Avo Test gear.

We carry Large Stocks of all Radio Components. High Voltage Condensers, Radio Valves, Mains Transformers, Coils, Chokes, Output Transformers, Speakers, Tubular Condensers of all types, Resistances, Etc., Etc. Our Unconditional Guarantee covers all goods. Satisfaction or money refunded. Send Id. for our Current List and Bulletin.

Terms: Cash with Order, *pro forma*, or C.O.D. No C.O.D. under £1.

## LASKY'S RADIO

370 Harrow Road, Paddington, W.9  
 (Opposite Paddington Hospital).

Telephone: Cunningham 1979

# Speaking of POWER SUPPLIES

Designers need no introduction to the Mercury Vapour Rectifier. Its advantages are quickly appreciated when good regulation in power supply is of paramount importance. But Mullard adds something else to consistent regulation and low initial cost. When manufacturing methods and processes keep pace with development, reliability in service is a foregone conclusion. This X-ray of the Mullard RG1-240A shows the internal construction of yet another valve with a proved performance.

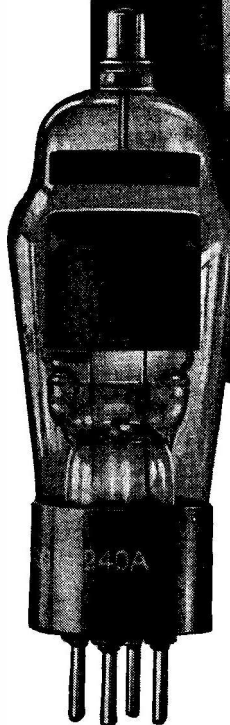

## RG1-240A

### MERCURY VAPOUR RECTIFIER

Peak Inverse Voltage .....	4,700 V
Mean Anode Current .....	250 mA
Two Valves in a Single-Phase Full-Wave Circuit will give 1,500 Volts at 500 mA	
Filament Voltage .....	4.0 V
Filament Current .....	2.7 A approx.

For further Developments watch

# Mullard

## THE MASTER VALVE



Write for: (1) Technical data and advice on the applications of the RG1-240A (2) New list of Transmitting Valves for amateur communications to:—  
THE MULLARD WIRELESS SERVICE CO. LTD., TRANSMITTING & INDUSTRIAL VALVE DEPT.,  
CENTURY HOUSE, SHAFTESBURY AVENUE, LONDON, W.C.2

---

---

---

---

---

---

# SHORT WAVE MAGAZINE

FOR THE RADIO AMATEUR AND AMATEUR RADIO

Vol. IV.

JANUARY 1947

No. 11

---

---

## C O N T E N T S

	<i>Page</i>
Editorial .....	657
Five Metres, <i>by A. J. Devon</i> .....	658
The Radio Amateurs' Examination, November, 1946 .....	663
Five-Band 25-Watt Transmitter, <i>by B. Randell, B.Sc. (GW3ALE), F/Lt., R.A.F.V.R.</i> .....	664
Short Skip on Five Metres—A New Theory, <i>by O. J. Russell, B.Sc., A.Inst.P.</i> .....	670
The NoYuGo Multi-Band Aerial, <i>by R. W. H. Bloxam (GM6LS)</i> .....	676
Planning the Amateur Bands .....	680
DX Commentary—On the Amateur Bands, <i>by L. H. Thomas, M.B.E. (G6QB)</i> .....	682
Calls Heard .....	687
First-Class Operators' Club .....	688
Meteor Reflection on VHF, <i>by Hilton O'Heffernan (G5BY)</i> .....	689
Break-In Operating Procedure, <i>by A. M. H. Fergus (G2ZC)</i> .....	690
New QTH's .....	692
Home-Made Relays, <i>by N. P. Spooner (G2NS)</i> .....	693
G9BF Calling .....	694
Here and There .....	695
Month with the Clubs, <i>Magazine 1·7 mc Club Contest</i> .....	696

---

---

**Editor:** AUSTIN FORSYTH, O.B.E. (G6FO). **Advertisement Manager:** P.H. FALKNER

*Assistant Editor:* L. H. THOMAS, M.B.E. (G6QB).

*Staff Assistant:* C. W. ANDREWS, M.C. (G2TP).

*Published on the first Wednesday in each month at 49 Victoria Street, London, S.W.1  
Telephone: Abbey 2384. Annual Subscription: Inland 20s, Abroad 22s, post paid.*

### AUTHORS' MSS.

*Articles submitted for Editorial consideration must be typed double-spaced with wide margins, on one side only of quarto sheets, with diagrams shown separately. Photographs should be clearly identified on the back. Payment is made for all material used, and a figure quoted in the letter of acceptance. A large stamped addressed envelope should be enclosed for the return of MSS. not found suitable for publication.*

---

---

THE SHORT WAVE LISTENER ASSOCIATED WITH THIS  
MAGAZINE IS SPECIALLY FOR THE RECEIVING ENTHUSIAST

# QUARTZ CRYSTAL UNITS

## FOR YOUR TRANSMITTER

### TYPE 2 LOW TEMPERATURE COEFFICIENT PLATES

3.50/3.75 Mc/s or 7.00/7.50 Mc/s for the  
30 Mc/s band.

3.66/3.75 Mc/s or 7.32/7.50 Mc/s for the  
60 Mc/s band.

PRICES ON APPLICATION

AVAILABLE FOR IMMEDIATE DELIVERY

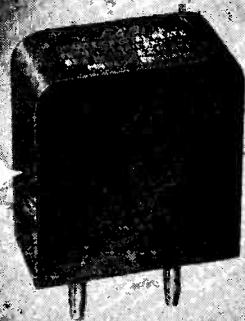

## FOR YOUR FREQUENCY STANDARD

### TYPE JCF/200 LOW TEMPERATURE COEFFICIENT BAR

Frequency . . . 100 K $\frac{c}{s}$

Accuracy . . .  $\pm .01\%$

Price on application

Vacuum mounted for optimum stability.  
A high precision unit of extreme stability,  
the crystal being nodally mounted on fine  
wires soldered to the bar.

DELIVERY FROM STOCK



**SALFORD ELECTRICAL INSTRUMENTS LTD.**

PEEL WORKS, SALFORD 3

Telephones: BLACKfriars 6688 (6 lines).

Telegrams and Cables: "SPARKLESS, MANCHESTER"

Proprietors: **THE GENERAL ELECTRIC Co. Ltd., of England**



EDITORIAL

# Co-Operation

With the turn of the year, our muse flows freely on many subjects of interest and importance in the wide orbit of Amateur Radio.

The World Telecommunications Conference, taking place in a few months' time and the issues of which cannot be forecast, will be of tremendous significance for the future of Amateur Radio. The new demands for space in the ether on a national and international scale exceed all previous requirements. Many readers would be astounded at the number of new services—in this country alone—needing the use of exclusive frequencies.

\*\*\*\*\*  
\* A Happy New Year To You! \*  
\*\*\*\*\*

This behoves us to use our own narrow spaces wisely and well and to respond as far as possible to all calls made upon us from official sources in regard to reserve organisations and the like. The amateur transmitter has made a large contribution in the past, but because the past is too soon forgotten, he must be prepared to make an even greater effort in the future. Only thus will the continued existence of Amateur Radio be fully justified.

In another direction, there is a widespread if somewhat illogical and unreasoning dissatisfaction with the internal organisation of Amateur Radio in this country. This is not the time nor is there the space here to discuss this particular problem in detail—though we may have more to say about it later.

But it is the season to say that so far as the *Short Wave Magazine* is concerned we are prepared—while maintaining our independent standpoint and avoiding either irresponsible criticism or blind acceptance of the existing order—to offer what assistance we can in putting matters right in the general interest of Amateur Radio.

*Arthur Frost*  
G6FO.

## Five Metres

### Contest Notes—The High Scorers—Trans-Atlantic Epic

By A. J. DEVON

**A**T the time of writing, we have a wad of reports nearly six inches thick covering Contest activity. From a quick check it seems that something like 100 stations were on for the event, distributed throughout the country, many of them active for the whole period! And there are still (December 17) a number of reports yet to come in. Many new callsigns appear in the lists, several from fresh localities in the 5-metre sense, and to them we offer a particular word of welcome.

#### Conditions Poor

But as all who took part know, we were certainly not favoured with a smile from Ole Man Condx. It might just as well be said here and now that from the point of view of large-scale GDX, the Contest was a flop. We have just never had 58 mc conditions so flat for so long!

We put this in here in spite of the fact that almost without exception entrants have said they enjoyed the fortnight, and many remark that they gained valuable experience from it. Practically everyone says "Let's have another." Well, stap us, not under the same conditions, surely!

So far as support and activity are concerned, then, the Contest was an outstanding and an unqualified success, far more so than we had dared hope. A great many stations (probably not less than 50 scattered over the country) put in long hours of what became very hard work in an effort to strain Zones C and D out of the mush. But the DX was just not forthcoming, and in round terms only the most persistent and best-equipped stations succeeded in making outside-the-local-area contacts.

The scoring was designed to pay a large dividend on GDX working;

had conditions materialised, this would have flattened out the advantages enjoyed by operators in districts where local 5-metre activity is normally high—for instance, there were quite 40 stations to work in the London and Home Counties area alone. Moreover, in order to try to catch a period of good conditions—even two or three days would have been enough—the Contest was set to cover a fortnight. Yes, we quite agree with all those who said it was too long, but there was the reason for it—and it would not have been too much if "October conditions" had returned.

It was just bad luck that during the fortnight November 23-December 8, even Zone C stations hardly showed up at all; but they were all there and trying hard.

#### Advantage of Location

Thus we have the situation where an operator working consistently in a well populated 5-metre district is bound to be the national winner in terms of points scored. The dice were loaded too heavily against those in more remote areas with comparatively few locals to work.

On the other hand, as pointed out in this space in November, the scoring rules simply invited competition between stations located in these areas of high activity. Roughly, therefore, the Contest resolved itself into a long spell of relatively intense local working among groups in all parts of the country, the top scorers in these areas being those able to make a few contacts outside their Zone B distances. Their *actual* scores depended entirely upon the number of Zone A and B stations within reach, and success with any DX that was going became a measure of station efficiency.

### The High Scorers

Due to there being several results not yet to hand, just for the present we do not propose to name the national winner nor the leading stations in localities from which reports have arrived or are expected. What we can do this month is to give the highest claimed scores so far received, as follows :

G6VX Hayes (334), G5MA Ashstead (221), G6LK Cranleigh (188), G6CW Nottingham (152), G2XC Portsmouth and G5BY Thurlestone (148), G2BMZ Torquay (128), G2MR Surbiton (105), G4AJ Basingstoke (104), G3CQ Romford (103), and G6YU Coventry (101).

Some of the lower scorers put up very fine DX performances in that they made sizeable scores with few Zone A stations to work. To bring out the real value of their efforts, one of the several analysis tables to be shown next month will be the scoring with Zone A's eliminated.

The full analysis, with details of equipment used, Zones worked and much other data, is now in preparation

for the February issue. The job is going to be very interesting, and though it will involve a great deal of work, it will not be at all difficult. This is because we can gratefully acknowledge the enormous trouble taken by all entrants to get their logs into shape in accordance with Rule (8).

So much for the Contest, for the time being.

### Trans-Atlantic Story

Last month's news flash summarised very briefly the reception of W1HDQ's 50 mc signals by G5BY and G6DH. We are glad to be able to show here-with new photographs of both stations and a glimpse of W1HDQ's QSL card to G5BY.

It is clear on the evidence of W1HDQ himself that G5BY was the first actually to identify the signal, G6DH following a minute or two later with the first cross-band 28/50 mc QSO. Truth to tell and as both will agree, there was very little in it. G5BY had worked hard for the contact for many months, having put out regularly scheduled 58 mc signals every week-

The 5- and 10-metre transmitter and VHF receiver at G6DH, Clacton, Essex. The receiver is a home-built acorn superhet designed by Denis Heighman himself, with a regenerative 954 mixer stage. It was on this equipment that G6DH made the first 50/28 mc cross-band Trans-Atlantic contact. W1HDQ's card says "Commemorating the first QSO across the Atlantic on 50 mc." November 24, 1946.



111 BUENA VISTA ROAD (Selden Hill) WEST HARTFORD, CONNECTICUT

V H F **W1HDQ** U H F

Radio G5BY Rig 6AG7/6V6/829/35T6's  
 Your 28.2 Mc Phone 50,002.3 kc.!  
 Wkd Hrd S9+2000 Receiver N H U  
 Date 11/24/46 Antenna 4-element rotary  
 Time 11:45 am EST OSL Hse!

73 E. P. TILTON *Ed*

*You were the first to hear a 50-mc sig. across the Atlantic!*

W1HDQ's card, confirming reception of his 50 mc signals by G5BY, as reported briefly last month. A note on the bottom edge of the card reads "You were the first to hear a 50 mc signals across the Atlantic!"

end since the beginning of June and spending long hours searching the American 50-54 mc band, with receiving equipment specially installed for the purpose.

G6DH studied the problem from the angle of strict probabilities in the light of the behaviour of the reflecting layers and the MUF. Having forecast the probable period for the opening of the path with considerable accuracy, he started daily schedules with W1HDQ early in November. They had made several attempts to contact when the MUF moved to 45 mc—evidenced by the big signals from the American 44 mc FM stations—but November 24 last was the first occasion it went over 50 mc. Fortunately, G6DH was there to take advantage of it—had the weather been fine, he would have been away from home. What a turn-up for the book!

By 1600, after several 28 mc checks with W1HDQ, things were obviously working up to a climax, with American 47 mc stations pounding in at S9. G6DH asked W1HDQ to call him on 50 mc at 15-minute intervals, and by

1621 they had made contact across "six-ten"; by 1630, W1HDQ's 'phone was a comfortable Q5, S8/9.

#### The Devon End

At G5BY, the details were different. At 1517 he started to hear a loud American, WEDI, as high as 52.9 mc—so strong that it was mistaken for a beat from the 28 mc VFO. This signal was identified, but had disappeared by 1600, when it was time for G5BY to push out the ten-minute auto-transmission on 58 mc. After this, 50-54 mc was searched with extreme care, and at 1617 W1HDQ was heard clear and steady at S6, announcing times and MUF data. G5BY immediately fired up the 28 mc transmitter and called "CQ Conn Rush" on 'phone; back came W1BEQ, who rapidly grasped the purport of the proceedings, and by 1621 had taken a message for W1HDQ from G5BY.

W1HDQ came on at 1645 to say he had received G5BY's message via W1BEQ, and this was followed by a cross-band 28/50 mc contact in the course of which W1HDQ confirmed

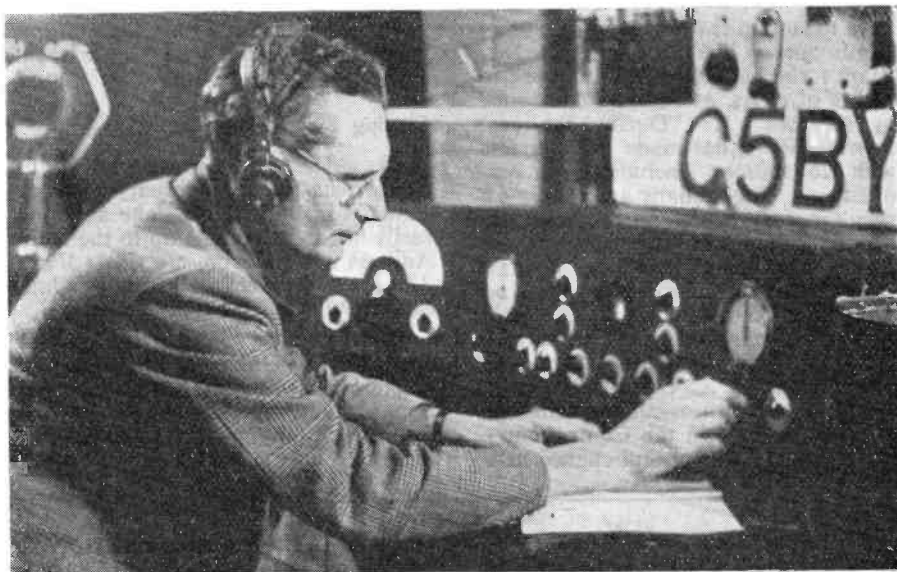

Hilton O'Heffernan, G5BY, of Thurstone, S. Devon. *The receiving equipment, entirely home-built like all the rest of the gear at G5BY, covers 1.7 to 60 mc. Superhet converters are used with a common IF/AF unit. The 50-54 mc converter is on the left.*

G5BY's reception details at 1617. Best reception of W1HDQ at G5BY was 20 dB over S9; there was no quick fade as on 28 mc, only a slow periodic rise and fall being noticeable with the speech Q5 all the time. The receiver for 50-54 mc is a three-stage 954 RF, 954 mixer, 955 oscillator, working as a converter with IF on 1.6 mc. The aerial is a four-element close-spaced beam, cut for 51 mc. It had been somewhat damaged in the gale, but even then produced a much better signal on W1HDQ than the 300-ft. rhombic, which also covers the States.

#### Future Possibilities

As to the future for 50 mc work of this kind, G6DH considers that the next good spell will not be until the end either of January or February. He thinks that March may give conditions producing paths across the equator for South Africa and South America. There was also the possibility of December 22 last being a good day, but if anything happened then it will have to be reported in our next!

#### Shorts

VK2NO reports that on December 5, 50 mc burst open in the Antipodes. He made first Australian inter-State contacts with VK3MJ (450 miles) and VK4AW (500 miles); he was also heard near Brisbane, 850 miles. Good work, Don, we know you are another sticker at this VHF business. The same period, December 5-7, saw several 1,000 mile VK3/VK4 contacts on six metres, and a Tasmanian was heard in Sydney. As VK2NO remarks, it was the pioneers who were there to cash in on the conditions; while they lasted, the going was good. . . . XE1KE is coming on 50 mc with high power and beams, so is a possibility. . . . ZB2A has a receiver on 58 mc, is getting a Tx ready, and in the meantime asks G's who want him to listen on five to fix it via 14 or 28 mc. . . . PAØRA will be on 59 mc as from January 1, in the evenings; located at Oosterbierum in Friesland. . . . G2DHY (Roehampton, S.W.15) heard 38 different stations on three evenings during the Contest. . . . Correction! G8LY tells us she doesn't

have to run up two flights of stairs and climb out on the roof to rotate her beam ; she only has to run up the two flights of stairs, as beam is controlled by strings ! . . . During the past month, G6YU has made 102 contacts with 26 stations, including six new ones. . . . The Italians are running a peculiar sort of 58 mc contest, the winner of which is to be the I whose signals are heard over the greatest distance during the ten-month period September '46 to July '47 ; all who have worked or heard I's, please be sure to QSL, as cards only are accepted as authenticators. . . . No 5-metre Calls Heard this month as all the information is contained in the Contest entry logs ; we missed a useful chance here

in not asking you to list the stations you heard but did not work ; we learnt a lot from laying on this Contest, too !

### Closing Date—February

Please let us have reports and Calls Heard lists for the February issue by January 18, but we can take anything really hot by telephone up to the 25th. Address A. J. Devon, c/o *Short Wave Magazine*, 49 Victoria Street, London, S.W.1 (ABBey 2384).

To very many readers, your earnest conductor's thanks for the season's greetings. All this month's letters will be answered in due course—in the meantime, a happy and a successful New Year on "Five."

### OBTAINING YOUR COPY

We know that many readers still have great difficulty in getting the *Short Wave Magazine* regularly each month at news-agents and book-stalls, and that its appearance is often much delayed.

These are matters over which we have no control whatever. We go to considerable pains to ensure publication regularly on the advertised date—the first Wednesday of each month—and bulk deliveries are made to wholesalers on that day. Like any other journal, we cannot control subsequent retail distribution.

Direct subscribers' copies are also sent to them by us on the day of publication, enclosed in a special envelope—not a wrapper—so that the *Magazine* arrives clean and undamaged.

If you want to be sure of it, the only suggestion we can make is that you become a direct subscriber. For 20s. you are guaranteed a copy each month for a year, posted to you on publication day. Send your cheque or postal order to the Circulation Manager, The *Short Wave Magazine*, Ltd., 49 Victoria Street, London, S.W.1.

But please note that we can only accept direct subscription orders to start with the next (February) issue of the *Magazine*. Our allowable print is still very limited and there are no back numbers available.

### NEW AMATEUR ORGANISATION ?

It has been suggested that the interests of amateurs generally might be better served by the formation of an entirely new association, membership of which would be open only to holders of transmitting permits.

There is much to be said for and against the proposal, which at this stage is put forward here only with the idea of sounding opinion on the subject.

The *Short Wave Magazine* is not at present committed in any way to the launching of a new organisation of this kind. But we should like to have your views, pro or con. Opinion will be summarised in an early issue.

As a matter of interest, we might add that the sponsors are suggesting the names "British Amateur Radio Society," "British Amateur Radio Transmitters' Association," or "Association of British Radio Amateurs."



### WODEN PRICES

Prices of Woden transformers, as quoted in our last issue, have been re-adjusted again. The fact is worth stating because they have been scaled *down* and not the other way, which is the prevailing tendency these days !

---

*The Short Wave Magazine covers the whole field of Amateur Radio*

---



# The Radio Amateurs' Examination

*Question Paper, November, 1946*

THE paper with which candidates were confronted at the Second Radio Amateurs' Examination on November 15 last is printed below.

As in the case of the first R.A.E., held in May—the questions set were published on p. 217 of our issue for June—the standard demanded in the present instance appears to us to be within the reach of anyone prepared to give a few hours a week to the study of the technique of Amateur Radio.

In the May examination, 182 candidates sat, of whom 145 passed, as mentioned on p. 438 of the September issue of the *Magazine*. The results of the November examination will be reported as soon as they become available.

All matters respecting the R.A.E. are dealt with by the Superintendent, Department of Technology, City and Guilds of London Institute, 31 Brechin Place, South Kensington, London, S.W.7, by whose authority this paper is published.

## 54—RADIO AMATEURS' EXAMINATION

*Candidates should attempt as many questions as possible. Use should be made of diagrams where applicable. The maximum possible marks for each question are shown in brackets.*

1. Why are frequency multipliers sometimes employed in radio transmitters? Describe, with diagram, a frequency-multiplying stage for a low-power transmitter. (10 marks.)
2. What is "fading," and how is it caused? (10 marks.)
3. Describe briefly the principles of operation of a superheterodyne receiver, illustrating your answer with a block schematic diagram of a typical receiver. (10 marks.)
4. The d.c. feed to the last stage of a transmitter is 250 volts, 60 ma. It is found that the h.f. current flowing in a load resistance of 500 ohms is 0.1 ampere. Calculate:—
  - (a) the power input;
  - (b) the power output;
  - (c) the efficiency of the stage. (10 marks.)
5. What are the advantages and disadvantages of directional aerials for transmission and reception? Describe, with diagrams, a simple directional aerial and explain its method of operation. (10 marks.)
6. Describe the principle of the heterodyne frequency-meter and explain how you would use it to determine the frequency of a received signal. (10 marks.)
7. (a) What is the purpose of key-click filters, and of what do they consist?  
 (b) An amateur transmitter on the 14 mc/s band was found to interfere with television reception on 41-45 mc/s. How was the interference probably caused and what steps could have been taken to minimise it? (20 marks.)
8. (a) What is the procedure laid down by the Postmaster-General for the use of call-signs when making and answering calls?  
 (b) One condition imposed by the Postmaster-General as regards "Non-interference" is as follows:—  
 "When telephony is used, the system of modulation must be such as to prevent the carrier-wave being modulated more than 100 per cent."  
 What are the objections to over-modulation, and how would you minimise the risk of over-modulating? (20 marks.)

# Five-Band 25-Watt Transmitter

## *Modern Design of Wide Application*

By **B. RANDELL, B.Sc. (GW3ALE), F/Lt., R.A.F.V.R.**

*The CO-PA unit described would serve either as a low-power CW transmitter or an efficient exciter for a full power RF amplifier. The circuit is one of the well-tried standard arrangements and no neutralisation is necessary.—Ed.)*

**T**HE transmitter described here is very simple to construct, adjust and operate, and for the newly-licensed amateur, it is a very reliable permanent transmitter. It has the advantage that when its owner graduates to a Class-B licence it may be used, with only very slight modification, as an exciter for a high-powered RF amplifier stage. The modifications necessary to convert it for this use are described in the section describing the present power amplifier.

The circuit is quite standard—tritet crystal oscillator and tetrode power amplifier. The PA employs the familiar 807, but instead of the more common 6L6, a 6V6G is utilised as the oscillator valve. The maximum grid current rating of the 807 is 5 mA and it is found that the 6V6G oscillator will drive the PA into 7 mA grid current when functioning as a tritet. Grid current of 3 mA has been found ample for loading up to an input of 25 watts, so it may be seen that there is plenty of drive in reserve. British equivalents, namely KT61 and KT8C, may of course be substituted for the 6V6G and 807 respectively.

The power pack used with the transmitter gives an output at 520 volts on load, and at this figure the PA can be run up to well over 35 watts input if necessary.

It will be noticed from the illustrations that the transmitter has been built up on a standard chassis and panel for rack mounting. The plated handles on the panel were not included just to improve its looks, as they undoubtedly do, for their purpose is threefold.

They serve to protect the panel, dials and meters from accidental damage when mounted in the rack; they allow the rig to be stood on the front panel during servicing operations; and finally, they facilitate handling when mounting in or taking out of the rack. For the latter reason all the rack-mounting gear at GW3ALE has been equipped with such handles, and they have been found particularly useful in the case of heavy power packs.

### Crystal Oscillator

The oscillator is designed to give an output on either 160 or 80 metres using 1.7 mc band crystals, and on either 40 or 20 metres using 7 mc crystals. The cathode circuit of the 6V6 is fixed tuned, and by suitable coil design it has been possible to incorporate a 100  $\mu\mu\text{F}$  mica condenser, C4, instead of the usual trimmer. The cathode coils are wound on standard 1½-in. ribbed formers and full information on them may be found on referring to the table of coil data. The coil in use is plugged into a 4-pin chassis-mounting ceramic valve holder.

Following usual practice, a switch has been incorporated so that the tuned cathode circuit may be shorted out when operating on the crystal fundamental frequency. Failure to observe this precaution will probably result in fracture of the quartz plate owing to excessive crystal current. In the circuit diagram it will be seen that an RF choke has been included in the grid circuit, but it should be noted that when Q.C.C. type P.5 crystals are used the choke may be left out in accordance with that firm's recommendation.



Half-rear view of the chassis. The 807 PA is in a screening can, with output tank coil and condenser to its left. The panel and chassis are of steel and obtainable in standard sizes for assemblies of this kind.

The anode circuit is conventional and utilizes a 160  $\mu\mu\text{F}$  ceramic insulated receiving type variable condenser. The rotor of this condenser is, of course, insulated from the chassis and panel as it is at a high DC potential. The coil design is such that a high C/L ratio is employed for harmonic operation and the output may be adjusted to the fundamental frequency merely by closing the cathode circuit switch and retuning the tank circuit. The tank coil is wound on a standard 1½ in. ribbed former and plugs into a ceramic, baseboard-mounting, 4-pin valve holder. The oscillator is coupled to the grid of the PA through a 50  $\mu\mu\text{F}$  ceramic cup-type condenser. In this connection it should be pointed out that the lead from this condenser to the grid pin of the PA must be kept as short as possible.

The oscillator power supply is taken

from the same source as that used for the PA and either the potential divider circuit shown may be used, or else R1 and R2 may be dispensed with, and a 25,000 ohm, 50-watt bleeder resistor, fitted with two adjustable taps, substituted in their place. In either case the anode potential of the 6V6G should be approximately 200 volts, and the screen 180 volts.

An American 5-pin ceramic valve holder is used for the crystal, the two diametrically opposed sockets on this holder being the correct spacing (¾ in.) for standard crystal holders.

#### Power Amplifier

The circuit used here is, again, quite conventional and employs circuit values recommended for the 807 by the makers. Bearing in mind the fact that the transmitter might at some time be used for 'phone operation, the screen voltage

for the 807 has been obtained by dropping the main power supply through a 50,000 ohm 10-watt resistor ; thus the amplifier may be plate-and-screen modulated by plugging the modulator output into the jack J.

Biasing is achieved by a combination of grid-leak and cathode resistor and hence no batteries are required. A normal receiving type RF choke and a 0-15 mA meter, or a metering jack, are connected in series with the grid resistor as indicated in the circuit diagram.

The anode circuit employs plug-in coils utilising standard ceramic bases and sub-bases, and the tank condenser is a  $100\mu\text{F}$ , 1,000-volt working variable, mounted on midget stand-off insulators.

No neutralisation is necessary for this power amplifier, but in order to obviate any possibility of "spilling over," the valve should be provided with a screen as shown in the chassis photograph ; the connection from the ceramic cup condenser, coupling the oscillator to the grid pin of the 807,

should be kept as short as possible as explained in the section dealing with the crystal oscillator. It is important that the leads between the coil and condenser of the 807 tank circuit also be kept short so as to minimise the possibility of parasitic oscillation.

#### Exciter Modifications

If the transmitter is to be used only as an exciter for a high powered PA or purely for CW operation, then the tank circuit of the 807 may be replaced by receiver type components such as are used in the oscillator stage, and the new tank coil may then be link coupled to the grid circuit of the following high powered stage. If required, the 807 may then be worked as a doubler and the versatility of the whole transmitter is increased, it then being possible to operate efficiently on at least three bands using 1.7 mc crystals ; alternatively, the crystal can be removed and a VFO coupled in.

#### Metering

This transmitter was built to be permanent, so that no matter what

*In the sub-space. All components can be seen and wiring is easy.*

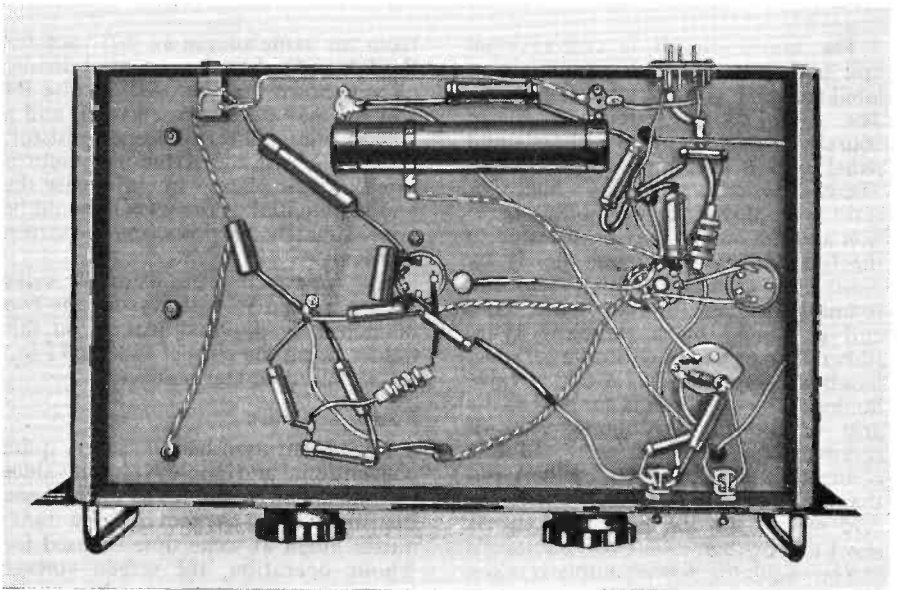

experimental work might be on hand at any particular time, it would always be possible to go on the air at a few moments' notice. It was therefore felt desirable to incorporate permanent metering facilities in the transmitter itself. Admittedly there were on hand three 3½-in. instruments which had been obtained as the result of a good bargain, but the employment of permanent meters in permanent equipment of this kind is recommended.

The meter used in the anode circuit of the oscillator reads 0-50 mA, and provided that the recommended anode voltage is not materially exceeded there is no fear of it going off-scale when the tank circuit is de-tuned. The PA grid circuit meter reads 0-15 mA and, again, is more than adequately rated for the job it has to perform. The PA anode circuit meter reads 0-150 mA, and as the anode current off resonance is about 90 mA, the rating of this meter also is quite ample.

If it is decided not to use permanent metering, then the instruments shown may be omitted and jacks substituted

for them. In this case it is necessary to have on hand a 0-150 mA meter for measuring either of the anode currents, and another having a full scale deflection of not less than 15 mA, but preferably not more than 25 mA (for reasonable accuracy of reading) for measuring the 807 grid current.

Alternatively one meter may be used, having a rating suitable for direct measurement of the PA grid current, and the other jacks provided with suitable permanent shunts to increase the scale.

### Keying

As will be observed from the circuit diagram, the key is inserted in the common cathode return of the valves. Provided that the keying leads are kept reasonably short there is no trace of key clicks and the transmitter has always been found to key very satisfactorily. No external click-filter is needed, the cathode resistors and their associated by-pass condensers in themselves constituting a filter circuit which is quite adequate.

Front panel view of the transmitter. Layout is simple but symmetrical, and therefore neat and effective. A standard panel is used, the unit as a whole fitting into a rack.

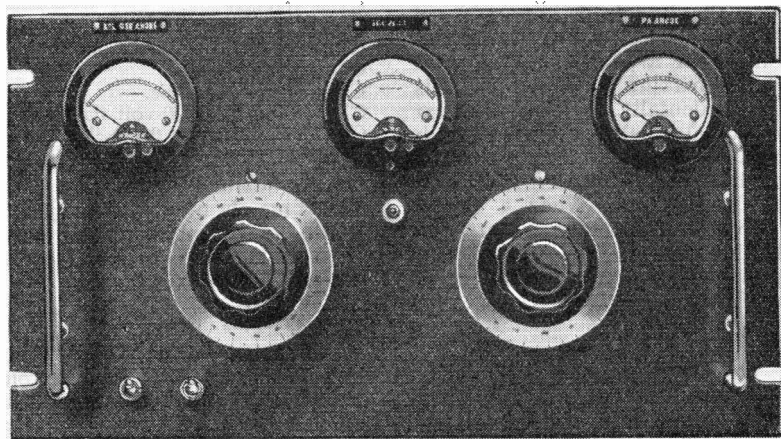

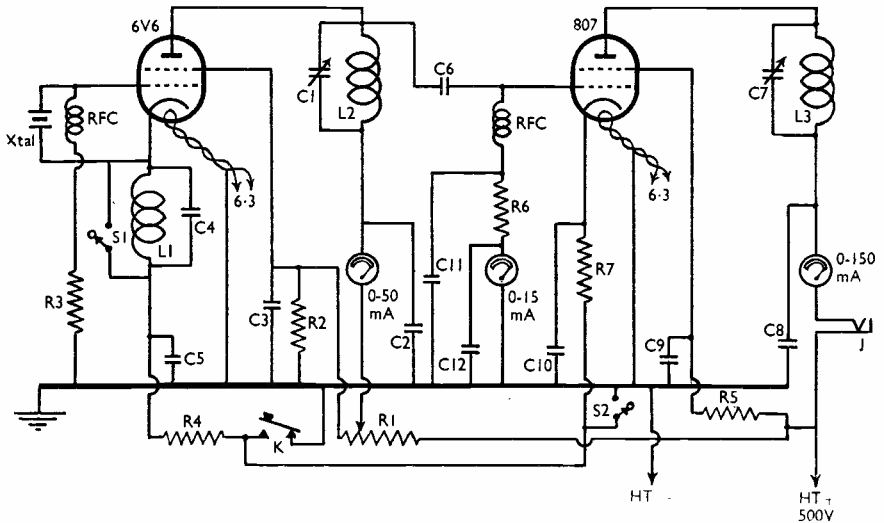

**Circuit of GW3ALE's tritet-CO/PA transmitter.** While being an efficient unit for CW operation at inputs up to 50 watts, it would also serve later as a very effective exciter unit for a high-power PA. Note that grid-block keying could be applied by returning R3, R6, to the bias line and using about 120 volts negative to cut off the valves; C11, C12, would probably have to be reduced in value to prevent chirp on the PA. All values are given in the table, and the construction of the transmitter is covered in the text.

Careful study of the photographs will reveal that no key jack has been provided. This is because it is intended to incorporate a keying relay on the chassis and so simplify break-in working which is so desirable. As yet the author has been unable to procure a suitable relay at what he considers a reasonable price, so as an interim measure the key leads are soldered directly across the switch which has been included to short the key contacts while making adjustments. This switch, incidentally, is mounted next to the oscillator cathode circuit switch and both may be seen in the photograph mounted at the bottom left-hand side of the front panel. When a keying relay is eventually included it is intended to take the necessary leads out through the power supply plug which is at present fitted.

### Modulation

As has already been mentioned, provision has been made in the power amplifier for plate-and-screen modulation. A jack has been mounted at the back of the chassis and connected in the anode and screen circuits so that

### TABLE OF VALUES

#### Five-Band 25-Watt Transmitter

- R1 = 7,000 ohms, 25-watt.
- R2 = 15,000 ohms, 15-watt.
- R3 = 20,000 ohms, 2-watt.
- R4 = 350 ohms, 1-watt.
- R5 = 50,000 ohms, 10-watt.
- R6 = 25,000 ohms, 2-watt.
- R7 = 250 ohms, 5-watt.
- C1 = 160  $\mu$ F.
- C2, C3, C5,
- C10, C11, C12 =  $\cdot 01\mu$ F, 1,000-volt test.
- C4 = 100  $\mu$ F, mica.
- C6 = 60  $\mu$ F, ceramic.
- C7 = 100  $\mu$ F, 1,000-volt flash-over.
- C8, C9 =  $\cdot 002\mu$ F, 1,000-volt test.

the modulator output can be connected merely by inserting a jack plug. Audio equipment having an output of 15 watts is more than ample for 100 per cent. modulation.

### Power Supply

The power supply used with the transmitter should be capable of giving an output of 500 volts at 120 mA and 6.3 volts at 1.5 amps. The power pack originally in use consisted of a heater transformer having 6.3 volts 4 amp and 5 volts



3 amp windings, and a 500-0-500 volts 150 mA power transformer, with a 5U4G rectifier and pi-section filter. Connection to the transmitter is made through 5-pin plugs and sockets.

### Operation

To operate the transmitter on the 1.7 mc band the cathode circuit shorting switch should be closed and a 1.7 mc crystal inserted in the crystal holder. The 160/80-metre oscillator coil must be used in the oscillator anode circuit and the 160-metre coil in the PA circuit. Power may now be applied, remembering to allow an adequate time for the cathodes to warm up before applying the high tension. Until familiar with the settings of the tuning controls it is advisable to insert a blank jack plug into J1 while tuning the oscillator stage, so that the 807 will not have to operate off resonance. The switch S2 should now be closed and the oscillator tank brought to resonance as indicated by a dip in the reading of the oscillator anode current meter and the appearance of a reading on the PA grid current meter. As previously mentioned, the same oscillator tank circuit coil is used for 160- as for 80-metre operation, so that care must be taken to ensure the tank circuit is in fact tuned to the crystal fundamental frequency.

When the oscillator has been tuned, remove the blank plug from J and resonate the PA tank circuit. It will be found necessary to detune the oscillator tank circuit slightly in order to bring down the PA grid current to a satisfactory level and to ensure that the oscillator will key correctly.

To operate on the 3.5 mc band using the same crystal as before, the tune-up is done in a manner similar to that described in the foregoing paragraphs except that the cathode circuit switch must now be left open; the appropriate oscillator cathode coil, and the correct PA tank coil must be used. Tuning is carried out as before except that the oscillator tank circuit must now be tuned to the second harmonic of the crystal frequency.

Operation on the 40- and 20-metre bands is similar to that on 160 and 80 metres, using 40-metre crystals and the appropriate coils.

It has been found difficult to make the oscillator give a satisfactory output in the 28 mc band, so when operating on "ten" the 807 is used as a power doubler, quite good efficiency being obtained. Hence, for operation on this band, the oscillator is set up in exactly the same way as for 14 mc operation, but the 28 mc coil is used in the PA tank circuit.

### COIL DATA

#### Cathode Coil

1.7 mc crystals	.. ..	32 turns, 22 SWG enam., close wound
7 mc crystals	.. ..	6½ turns, 22 SWG enam., ¾ in. long

#### Oscillator Tank Coil

1.7 and 3.5 mc	.. ..	42 turns, 22 SWG enam., close wound
7 and 14 mc	.. ..	9 turns, 22 SWG enam., 7/8 in. long

#### PA Tank Coil

1.7 mc	.. ..	56 turns, 22 SWG enam., close wound
3.5 mc	.. ..	35 turns, 22 SWG enam., close wound
7 mc	.. ..	18 turns, 14 SWG enam., 2½ in. long
14 mc	.. ..	9 turns, 14 SWG enam., 2½ in. long
28 mc	.. ..	4 turns, 14 SWG enam., 2 in. long

Note: For all bands covered, all coils in the oscillator circuit are wound on standard 4-pin 1¼ in. ribbed formers.

For 160 and 80 metre operation, PA tank coils are wound on 1¾ in. paxolin tube, mounted on standard ceramic plug bases.

For 40, 20 and 10 metre operation, PA tank coils are wound on standard 2½ in. ceramic formers.

## Short Skip on Five Metres

### *A New Theory on the Propagation of 58 mc Waves at Medium Distances*

by O. J. RUSSELL, B.Sc., A.Inst.P.

*(Over a period of years, our contributor has applied himself to an analysis of the results reported in A. J. Devon's regular feature "Five Metres." This study suggests the presence of a short but persistent skip effect of 60 miles—giving also second, third and fourth hop reception at 120, 180 and 240 miles—for frequencies in the region of 60 mc. He deduces the presence of a very low-level ionised layer, at a height of 5-10 miles only, as being responsible for this phenomenon. He argues that the existence of such a layer, already suspected by other workers but never proved, is brought within the realm of practical possibility by his analysis of the results obtained on the 58 mc amateur band. We are glad to give space to the discussion of these theories, and feel that this article will arouse wide interest.—Ed.)*

IT should perhaps be stressed at the outset of this article that the results and conclusions obtained here are based exclusively upon data obtained from "Five Metres" in the *Short Wave Magazine*. Its active and progressive policy with regard to 5-metre work has not only stimulated regular activity on the band, but the *Magazine* has been the only one regularly to publish reports in a form which is of value for the investigation of VHF wave propagation.

Consistently, over a considerable period, the 5-metre section has listed each month contacts between distant stations and in most cases has given the distance between the two stations—or between the station and the receiver in the case of reception reports.

It is only through the activities of the amateur fraternity that such a great number of observations on 5-metre signals, over such a length of time, could have been obtained. It is obvious that as the reports represent in effect a large number of observers scattered all over the country, any conclusions based upon them will not be likely to be influenced by purely local effects. Thus, the results will be generally applicable.

Equally obvious is the fact that results of comparable value and validity

could hardly be obtained by any means other than Amateur Radio.

#### Pre-War Research

It is also clear that in those cases where the distance separating the receiver and the transmitter is given, an analysis of the results could be of value in deciding if any skip-distance effects are noticeable. Thus, if it is found that over a certain range, reception or contact reports are consistently abundant or scarce as the case may be, there might be a suggestion that some sort of skip-distance effect was operating.

It was therefore considered of the utmost importance to sift and analyse the mass of 5-metre data that has been published in this *Magazine*, in order to try to track down any such effect, if it existed. The writer originally commenced the task in 1938, using the 5-metre notes as the source of information.

Almost immediately, it became apparent that very definite skip-distance effects were in fact present, and the observations were checked with the aid of the fresh data appearing every month, until these proved the matter beyond reasonable doubt.

With the re-publication of the *Short Wave Magazine*, and the further

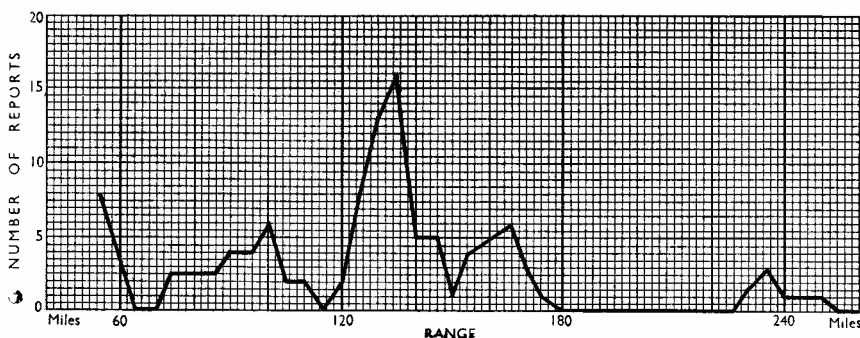

Fig. 1. Illustrating the pronounced peak in contact reports near the 120-mile distance. Data for this curve were extracted from "Five Metres" in the August, 1946, issue.

reporting of 58 mc activity, the writer proceeded to reconstruct the original work using the new figures published. These checked exactly with the pre-war results, and the whole mass of data was then rechecked in order to establish the findings without possibility of error.

It is now possible to present these findings in such a way as to bring out the salient points with the minimum of explanation, as the diagrams show in quite unmistakable fashion the conclusions that had previously been reached by rather more complex mathematical methods.

### The Analysis

The problem being one of finding whether skip-distance effects are operating to cause reception to be easier over certain distances, and more difficult over others, the simplest approach is to find the way in which station reports or contacts are distributed with distance. In order to do this, the ranges are divided into ten-mile portions, and the number of stations within each ten-mile portion were counted from the reports published. Thus, the number within the range 30 to 40 miles being, say, ten for a particular period, and the average distance being 35 miles, this is counted as ten at 35 miles average range.

Similarly, the range 35 to 45 miles gives a number of stations counted as the figure at an average of 40 miles, and so on.

It is clear that if at a range of, say,

100 miles, there is any factor causing extra signal strength for signals over this specific distance, when a large number of reports are examined, this will show up in an extra number of stations being counted at this average range. In counting the reports, each reception report counts as one, while a two-way contact counts as two reception reports.

Each month, all the reports for that month have been counted. However, as the object is to disentangle a possible enhancement of the chances of hearing a distant 5-metre signal over any specially good distance, it has been necessary to guard against introducing an increase in the figures at any one distance through a particular pair of stations working each other several times in one month. In such a case, where two stations have had several contacts in the one month this has been counted as only *one* contact for that period; although, of course, a further contact or contacts by these stations is counted when it is again reported in a subsequent issue, for a different period.

While this may seem to be rather hard on a pair of stations effecting a regular series of distant contacts over a period of several days, it at any rate renders the final figures free from any artificial increase not due to propagation conditions as such.

### Results of the Analysis

The results obtained are perhaps better illustrated by suitable selections

from the curves drawn from them. In these curves, the horizontal scale gives the average distance in miles. The vertical scale gives the number of stations heard within a ten-mile band at an average distance plotted on the horizontal scale. Thus, for an average distance of 40 miles, the figure plotted is the number of stations reported over the range from 35 miles to 45 miles.

The first and most characteristic feature noted when examining the very first reports in this graphical way is that over a distance of 120 miles approximately, there is a very distinct peak in the number of reports. The very first graph plotted from a few reports available showed this so clearly and definitely, that it was obvious that further investigation to determine whether this feature was permanent or not was likely to be of the very greatest value.

Obviously, a consistent peaking of results around some specific distance could only mean the operation of some skip-distance effect, a feature of five-metre propagation over medium ranges that has never hitherto been considered. (The occasional skip effects over greater distances of several hundred miles due to sporadic E-layer effects is excluded here by consideration only of results up to two hundred miles or so.)

Furthermore, any consistent skip effects would be strong suspicion of the existence of very low-level ionised layers, such layers having in fact been postulated by ionosphere workers previously.

A typical graph showing this peaking effect is provided by Fig. 1, which is

actually the graph obtained from the 5-metre results published in the *Short Wave Magazine* for August, 1946. The very large peak in this case is at 135 miles. It will also be noted that there is a smaller peak in the region of 240 miles, the peak here being at 235 miles. This appears, at first sight, to be convincing evidence of a reflection effect, i.e. a "first hop" of 120 miles and a second hop of 120 miles causing peak reception and transmission paths for distances of 120 miles and 240 miles respectively.

However, the evidence of a single month's results is hardly sufficient for any such sweeping assumptions, especially with only a relatively few reports to go upon. From the individual graphs, and from the totalled reports, certain definite features emerged.

### 60-Mile Periodicity

It became evident that the true skip-distance was not 120 miles, but actually 60. This 60-mile periodicity was not only shown by details in the individual graphs, but was also apparent in the graph obtained by totalling *all* the reports.

As a further check, an averaging method was utilised in order to obtain a smoothed graph free from irregularities due to possible skip-distance effects. This was then superimposed upon the graph of the original results, and a curve plotted of the way in which the irregular curve varied from the smoothed curve. This, again, gave a very clear indication of the 60-mile periodicity. As a typical example of this 60-mile effect, the results from the May, 1946, issue are graphically

Fig. 2. Showing the peaking effect at 60-mile intervals. Data extracted from the May, 1946, issue.

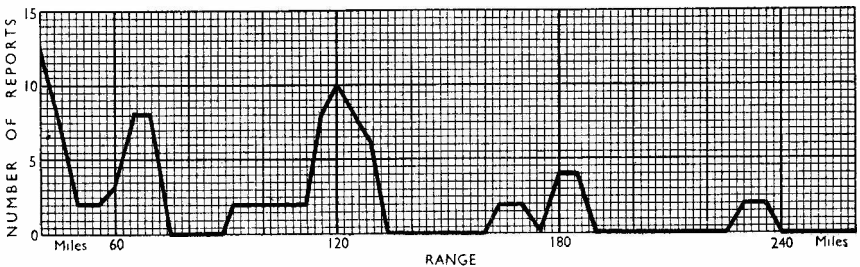



Fig. 3. The curve obtained by totalling all reports for the period May-November, 1946, as given in "Five Metres" in those issues. The 60-mile periodicity is very clearly shown. The author's contention is that this evidence points very strongly to the existence of a low-level ionised layer capable of returning 58 mc waves.

expressed in Fig. 2. Peaks are very clearly shown at distances of 60, 120, 180, and 240 miles approximately.

Perhaps the most striking feature of all this is the very clear and definite way in which this 60-mile skip shows up. The persistence with which it emerges in the analysis of almost any of the groups of reception reports shows that the phenomenon responsible for the effect is stable. Scientific theories of great importance have, in fact, been based on results far less clearly shown than in this 60-mile alternation of areas of enhanced signal strength. In the early days of struggling with the mass of data, when the 60-mile alternation was apparently in danger of being submerged beneath a host of minor variations, the tangled curves were subjected to the averaging process already mentioned. This revealed that the submerging of the 60-mile periodicity was, in fact, an illusion, and the difference curve revealed it as clearly as before.

To prove how the periodicity is, in fact, clearly apparent, even when results are totalled over a period, Fig. 3

is the graph representing the sum total of all reports contained in the issues May to November, 1946. It will be observed that there are three distinct peaks in the curve corresponding approximately to 120, 180 and 240 miles ranges. Furthermore, it will be seen that there appear to be subsidiary bumps preceding the main peaks, as though two closely similar effects were in operation at the same time. This double-effect would seem suspiciously akin to a double ionised layer, similar to the normal layers responsible for known skip effects, but much closer to the earth. The comparatively short 60-mile skip effect could then be obtained, even at the very narrow angles of incidence necessary for consistent 58 mc reflection from layers of not exceptionally high ionisation.

#### Low-Level Ionisation

The existence of ionised layers only a few miles high has previously been claimed, but the results here obtained would appear to be very strong proof of this theory. In order to display this skip effect and double peak effect more

clearly, Fig. 4 is an actual example of the difference curve obtained from the smoothed curve representing propagation conditions in the absence of skip effects (Fig. 5). The maxima are seen to be at distances almost exact multiples of 60 miles, while the minima are separated by 60 miles. The double peak effect is also clearly shown.

### Discussion

The writer puts it forward that the results here discussed are, in fact, almost certain evidence of a genuine skip-distance effect, probably due to low-angle reflection from very low-level ionised layers. As is well known, very great increase in signal strength and improved ranges on the ultra-high frequencies are produced by temperature inversions in the lower atmosphere.

However, it is difficult to see how a skip-distance effect of the nature shown above could be caused by this. As the term "ducting" indicates, the effect is to enhance signal strength generally over a wide range. The results for the June issue of 1946 would appear to represent conditions under which there was little or no ionisation, but ducting was active. As can be readily seen, the station reports are distributed almost uniformly over the range. This is

certainly the type of propagation to be expected from ducting.

The almost general bunching effect of reports at or about distances which are not only separated by 60-mile intervals, but which are themselves multiples of 60 miles (that is to say, 60, 120, 180 and 240 miles) is definitely a phenomenon not to be associated with ducting. But it is very closely like what would be expected from ionised layer reflections.

Moreover, the definite indication in the totalled curves of a double peaking effect seems to fit in very significantly with the usual condition of a double ionised layer consisting of two such layers close together. It should be stressed that for reflection at a very low angle from these hypothetical ionised layers, at a height of only a few miles, a high degree of ionisation is not required. In fact, the layers, while able to reflect almost glancing incidence rays, would not offer any barrier to waves arriving at more nearly normal angles.

The value of low-angle radiation in normal long distance work on the lower frequencies is well known. In the case discussed here, it would appear that if the 60-mile periodicity is due to reflection from ionised layers, these would

Fig. 4. A typical "difference curve," which again reveals very distinctly the 60-mile periodicity.

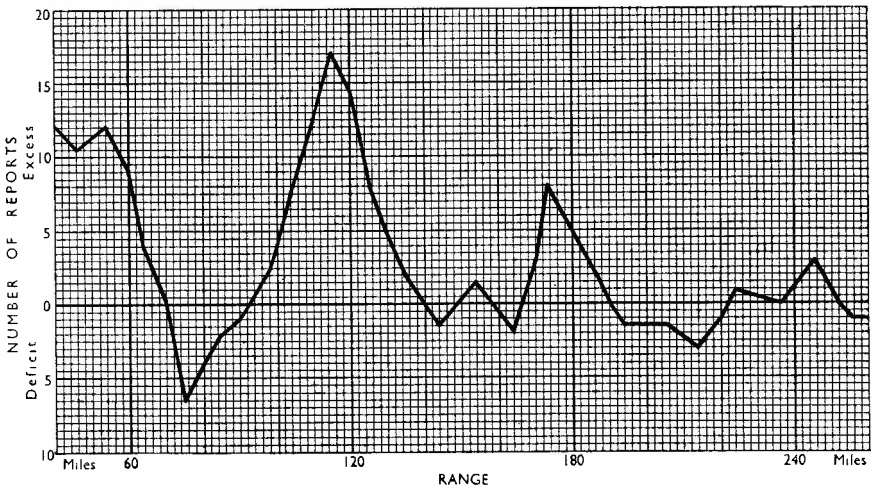



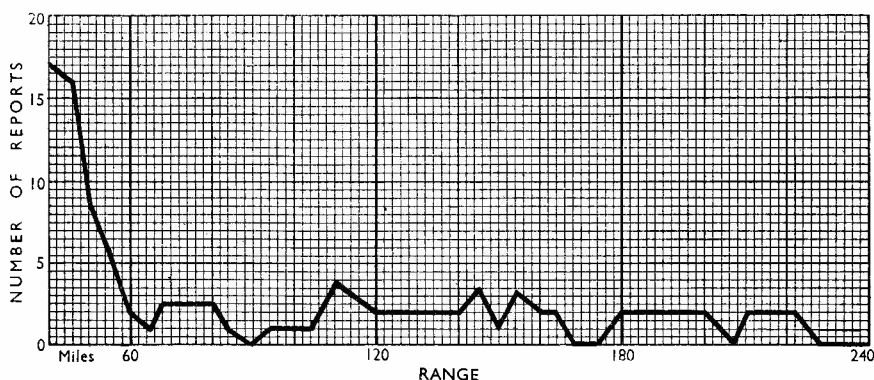

Fig. 5. Curve drawn from the June, 1946, reports appearing in "Five Metres." The peaks are suppressed, and the author suggests that in this instance propagation was probably due mainly to ducting.

necessarily be at a low height, probably of the order of five to ten miles. The skip distances observed would actually necessitate extremely glancing incident rays for these distances. These arguments would also explain why the existence of such layers has not previously been definitely established, owing to the need for very low angle radiation to reveal them. As mentioned before, the existence of such layers, at a height of only a few miles, was suggested some years ago.

It should be explained that these arguments have no bearing as such upon the known and established phenomenon of ducting. The results discussed do show, however, that there is a *persistent additional* effect causing peaking at the stated distances. Probably but for ducting tending to keep the signal strength up at intermediate distances, the curves would drop to zero between the peaks. The curve for the June 1946 issue reports would, in fact, represent what could be expected if ducting were the only cause operating. But in practically all reports examined each month the peaking effect at the "preferred" distances is clearly indicated. It is astonishing that this feature is so clearly marked. Even a single case such as the May issue curve, shown in Fig. 2, would be regarded as significant, were it not supported by the additional evidence obtained from reports ranging over nearly three years.

The fact is that this peaking feature is clearly shown, *even* when the reports for several months are lumped together in a composite curve (Fig. 3).

It must be admitted that these results, previously unsuspected, are highly significant, whatever the ultimate conclusion that is reached about them. It may also be said that the very complete data necessary to prove the effect could only have been obtained through Amateur Radio. It is extremely unlikely that any research organization could afford to conduct—either in time, personnel or money—an investigation upon the scale approaching this, and it is doubtful if results of any value would be obtained without a comparable effort.

It is to be hoped that the present support for and interest in activity on 5 metres will result in still more data being supplied. All reports of 5-metre contacts and reception over ranges greater than 29 miles are of value for future work.

The Editor of the *Short Wave Magazine* has kindly agreed to allow an article embodying the mathematical analysis and proofs of the foregoing results and conclusions to be prepared for certain scientific periodicals in this country and abroad.

It is felt that this investigation may be of interest to other workers on ionosphere problems.

# The NoYuGo Multi-Band Aerial

Devised by R. W. H. BLOXAM (GM6LS)

Where only one transmitting aerial can be erected, the amateur with limited ground space at his disposal is faced with a problem in making this aerial operate efficiently on all bands.

The problem is complicated if, as in the writer's case, the line of the aerial cannot be orientated in a direction favourable to propagation along the general DX paths.

Efforts to solve this problem at GM6LS date back to long before the war, and a number of aeriels—folded, straight, horizontal and vertical—have been tried. The aerial described has proved the most satisfactory for multi-band operation, and its performance for DX has been outstanding.

Local conditions of terrain, height and obstructions play a big part in aerial performance, and it is not suggested that this one is necessarily the best for a particular situation. But if conditions are similar, it might be worth trying, as the construction is simple.

At GM6LS the line of the aerial is NW-SE, the station being toward the SE end. The height is about 30 ft. only. The mast end is on a halyard, so that the aerial can be raised and lowered easily.

Ability to bring the centre of the "flat-

top" to within reach is an essential feature, as will be seen later.

## Multi-Band Requirements

Use for the 1.7 mc band dictates that the aerial be as long as possible, since the lengths of 50 to 100 ft. generally feasible in most situations only represent a fraction of the wavelength, and anything less is not of much use except for local contacts. Much the same considerations apply to the 80-metre band. No appreciable control of directivity can be achieved on either of these bands, and the usual practice is employed of tying the feeder ends together at the transmitter end, and working the whole thing against ground. On 7 and 14 mc, however, dipole horizontal tops become practicable, and even the 66-ft. top requisite for a 7 mc dipole is obtainable in most locations.

Now, it is well known that a dipole exhibits marked broadside radiation characteristics, whilst the use of a top of length greater than a half-wavelength produces a series of lobes in the horizontal plane, the axes of which lie closer to the axis of the aerial as the length is increased (see Fig. 1).

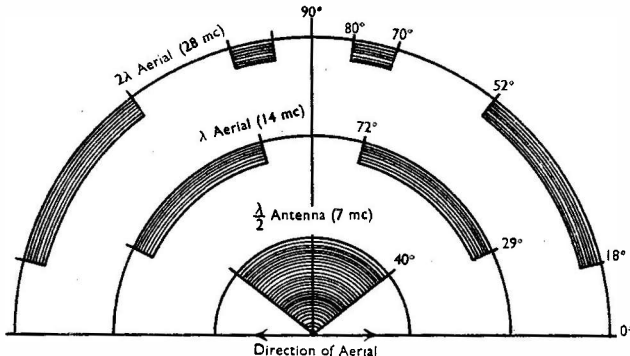

Fig. 1. Directivity of a  $\frac{1}{4}$ -wave, full-wave and double-wave aerial. This is the theoretical horizontal polar diagram for a wire in free space (the radiation pattern off one side only is given), and shows the plan angles at which major lobes occur for low-angle radiation. GM6LS's "NoYuGo" involves the use of a 7 mc  $\frac{1}{4}$ -wave wire; when excited by the feeder system he describes on the 7, 14 and 28 mc bands, it will give theoretical coverage as indicated above. The directions are, of course, repeated in the two quadrants below the line of the aerial in the drawing.

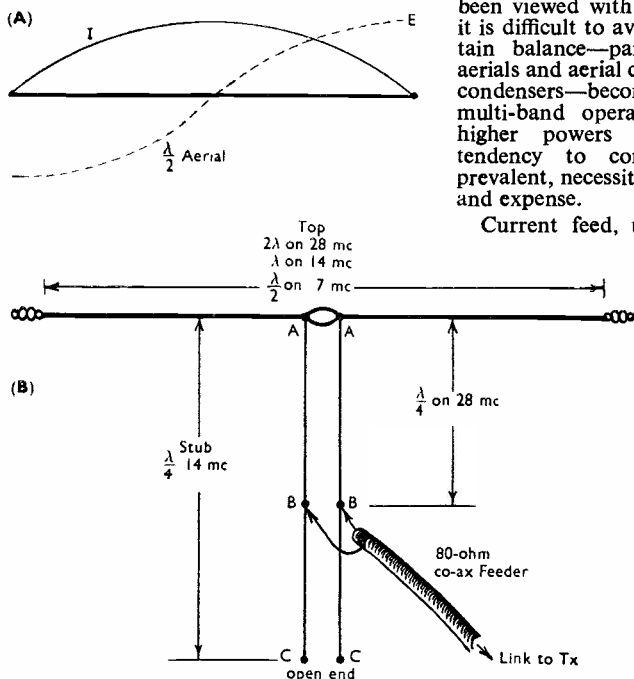

Fig. 2. The coupling system for the "NoYuGo." On 7 mc, the co-axial feeder goes to the centre of the aerial, A-A, as for any dipole. On 14 mc, it goes across points C-C, and on 28 mc across B-B.

Unless a dipole can be erected approximately N-to-S it is, therefore, not the best form of aerial for the DX bands 14 and 28 mc. On the contrary, some form of long-wire aerial is desirable at these frequencies, in order to bring lobes to bear in the required directions.

Since 7 mc is hardly a DX band any longer—except perhaps for the B.B.C!—the use of a dipole top cut for this band will suffice for general operation on it, irrespective of aerial direction.

Assuming, then, that a 66-ft. top is erected, its use on 14 and 28 mc as a full-wave and two-full-wave aerial respectively will provide a more desirable lobe distribution, whilst operation on 1.7 and 3.5 mc with the feeders tied and operated against ground will give reasonable efficiency.

The problem therefore resolves itself into one of feeding the aerial efficiently on the three HF bands.

### Feeding and Matching

The use of tuned feeders has always

been viewed with distaste because at HF it is difficult to avoid losses, and to maintain balance—particularly with end-fed aerials and aerial coupling coils and tuning condensers—becomes a nuisance for multi-band operation. Also, with the higher powers permitted to-day the tendency to condenser spark-over is prevalent, necessitating wide spacing, bulk and expense.

Current feed, using a simple untuned link to the PA tank and a co-axial feeder, connecting into a current loop point on the aerial is modern, simple and efficient.

Consideration of the application of this method to an all-band system led to the conclusion that a compromise was necessary, either in respect of efficiency or convenience. It was decided to maintain efficiency, and to sacrifice shoe leather to the cause of DX! The sacrifice lies in the fact that in order to change the working

bands it is necessary to go outside and shift the position of the aerial end of the co-ax feeder.

This hardship is not found too serious at GM6LS, as the station is managed—like many old-timers to-day—by both a senior and a junior operator. So that on fine warm evenings band QSY provides a refreshing breather for the old man, whilst on a less favourable occasion he may elect to change over the PA, while the junior operator toughens up outside! Of course, if the junior operator gets too tough about the idea, we may not QSY at all, but just stay put on the band we are on already. This interesting psychological situation led to the christening of the aerial as the "NoYuGo."

### Design of the Feeder.

Fig. 2 (A) shows a 66-ft. 7 mc dipole and the current distribution along its length. A current loop at the centre enables the feeder to be attached at that point, using low-impedance (80-ohm) co-axial cable.

The same top used on 14 or 28 mc has a current distribution such that the centre becomes a current node (voltage loop) and the low-impedance feeder cannot be attached at this point. If it is, the PA refuses to load up, because of the mismatch. Obviously the co-ax can be applied if the point of feed can be moved a quarter-wavelength (at the frequency to be used) away from the centre.

This can be accomplished by inserting a stub a quarter-wavelength long at the centre of the aerial, connecting the feeder to the other end. The effect is the same as adding another half-wave into the aerial, except that since it is folded, the added portion will be non-radiating. However, two different stub-lengths are necessary for the 14 and 28 mc bands, the length for the former being approximately twice that for the latter. This led to trying out the idea shown in Fig. 2 (B), in which the open-ended stub is about a quarter wavelength long on 14 mc and hangs vertically from the top portion.

For 7 mc operation the stub is not required, and the co-axial feeder is attached at points AA.

For 28 mc the point of attachment is BB (quarter-wave at 28 mc below the centre) whilst for 14 mc the whole stub length is required and the feeder connects at CC.

The presence of the unused portion of the open stub at 7 and 28 mc has no effect as far as can be ascertained. The stub comprises an open-wire twin-line of 16-gauge wire spaced 3 in. apart.

The top of the aerial was cut for 28,500 kc. It is best to cut the roof to the length necessary for the highest frequency band.

Since on 28 mc the top is two wavelengths long, the physical length is somewhat shorter than four times the length of a dipole at this frequency, owing to end effect.

The length may be calculated from the formula :

$$L \text{ (ft.)} = \frac{492 (N - 0.05)}{\text{Freq. (mc)}}$$

Where N = the number of half-waves in the top (4 for 28 mc). The stub length is given by :

$$L \text{ (ft.)} = \frac{234}{\text{Freq. (mc)}}$$

The stub length is actually made 17 ft., so that on 14 mc the feeder taps on a few inches above the bottom end.

### Adjustment and Operation

Begin with 28 mc. Attach the co-axial feeder to a point roughly half-way down

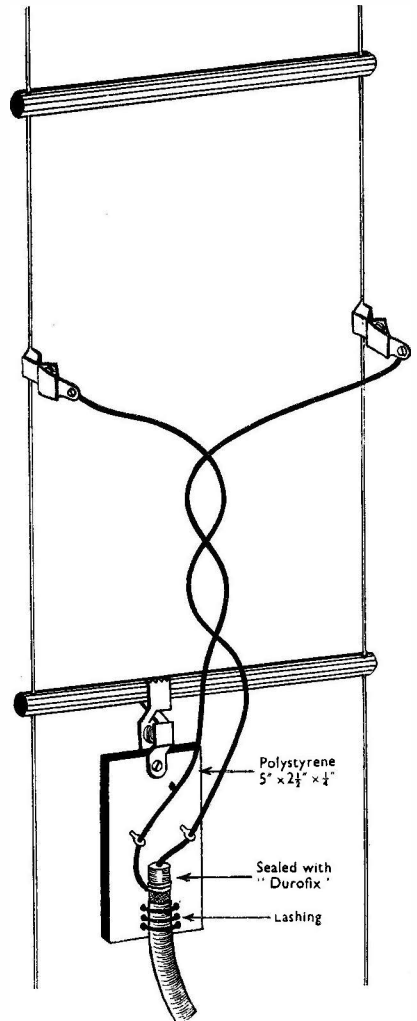

Fig. 3. Detail of the feeder connection arrangement. This takes the strain off the co-axial cable. The matching stub spacing is 3 in. between the wires.

the stub, inserting an RF ammeter in series with one side of the co-ax at this point.

The clips are now moved above and below this position about 2 in. at a time until maximum current is indicated. At each setting the coupling of the PA tank circuit link is adjusted for constant power input to the PA. The stub wires are

marked when the correct position of attachment is found. The same process is employed to determine the position for 14 mc with the feeder clipped on near the bottom.

The co-axial feeder used at GM6LS is surplus 80-ohm polythene dielectric and is about 7/32 in. overall diameter. It is thus light and flexible.

The centre impedance of an aerial more than one-half wavelength long is greater than 80 ohms, and this is compensated for by the tapping arrangement of the feeder. The length of co-ax is 40 ft., but any length may be used.

To facilitate quick re-connection and relieve the co-ax from strain the arrangement shown in Fig. 3 is used. The clips are strong battery-charger type and ensure firm contact.

### RADIO VALVE VADE-MECUM Sixth (1946) EDITION

Once again, we are glad to draw readers' attention to this excellent publication, which is a revised and enlarged edition of the previous issue, reviewed on p. 311 of the July number of the *Magazine*.

The present edition of "Radio Valve Vade-Mecum" contains some 220 pages of data and so far as is possible covers every known type of valve in detail. English, American, Russian, Italian, Allied Service and all other Continental makes are included, classified in eight Tables.

It is not pretended that the information is absolutely complete, as there will always be new or obscure types that have not yet been listed. The real value of the Vade-Mecum probably lies in the fact that it gives such complete data on the Continental valves, of which there are so many different makes. However, all new European and American types are included and full data also given on those which were in use in the German and Italian services.

Purchasers of the 1946 Edition of this publication will receive a free quarterly supplement to keep the lists up-to-date, since it is intended that the 1947 Edition will be an entire revision, issued on a new basis and in a new format. It will thus not appear till late next year.

### Performance

On 28 mc it appears that there is considerable "end-fire" effect. With this aerial reports from W and VE jumped from S 5/6 to S 7/8 with frequent S9 and 9+ as compared with a dipole on the same line. In October all W and VE districts were worked twice on 'phone. The direction of Seattle and Vancouver, which both gave good reports, lies almost exactly along the projected line of the aerial, and the lobe below the SE half puts good signals into ZS.

Performance on the other bands is also satisfactory, and the aerial is recommended to anyone with the same problem as that of the writer—an all-band system with space only for a 7 mc top. Readers who try the arrangement are asked to comment on their results in comparison with other systems, particularly on 28 mc.

---

**Radio-Valve Vade Mecum:** English Edition, with free quarterly Supplements. 232 pp. Published by P. H. Brans, Antwerp. Price 12s. 6d. post free, of the British agents, Messrs. Ritchie, Vincent & Telford, Ltd., Harrow, or The Modern Book Co., Paddington.

### BROWN'S MOVING-COIL HEADSETS

The new moving-coil headsets now being marketed by Messrs. S. G. Brown are a very fine example of the combined arts of the designer and the production engineer.

Light in weight, pleasing in appearance, sensitive and of particular application where high quality or laboratory standards are required, these instruments are precision-built to close limits and are sealed off after assembly. The impedance is 104 ohms at 1,000 c.p.s., and the sensitivity 8 dB above one microwatt. A transformer is available, in two types, designed to match 2 to 10,000 ohms in six values, so the headset can be used on all usual outputs.

For many years, Brown's 'phones have been synonymous with quality. This new product is a worthy addition to the long line of designs accepted as standard all over the world.

---

*Mention the Magazine when writing to Advertisers  
It Helps You, Helps Them and Helps Us*

---

# Planning The Amateur Bands

## Suggested Divisions of the 1·7-28 mc Ranges

*(We are well aware that of all the difficult and thankless tasks we could undertake, that of Band Planning is likely to draw upon our heads more criticism—and to engender more misunderstanding of our motives—than almost anything else. But in the general interest and in the belief that it is high time something was done, the article below sets out what is in effect present Magazine opinion on the subject. The idea is to try to get people thinking. It is not policy till we have heard what you do think. Please write!—Ed.)*

Now that the full widths of the 7 and 14 mc bands are open for amateur use, it would seem that we have all the DX frequencies that we are likely to be granted for some time to come. Any improvement in the QRM situation—or even the state of successfully holding it down to its present level—will therefore not be assisted by the possible opening of more frequencies in the future, but remains entirely up to us, the users. There are the bands, and we have to fit into them somehow, and like it!

What is being done about it? At the moment, precisely this: Anyone, from the grey-bearded old-timer of a G6 to the proud and shiny new G3-plus-3, gets his transmitter working within the limits specified (we won't mention those who still go outside) and proceeds to operate to the best of his ability on CW or 'phone, and to collect QSO's as best he can. That is about the sum total of our band-planning at the moment.

What are we going to do about it? And who is going to do it? Because someone had better start thinking, and really soon.

Our GPO (perhaps unfortunately, in some ways) takes the attitude that the segregation of 'phone and CW is a matter for amateurs themselves to decide and enforce. It does not propose to legislate in this manner as the FCC has done in the U.S.A. So any "split" must be a voluntary one, agreed upon by the majority of licensed amateurs.

The suggestions put forward here are, therefore, merely by way of being a speech by the proposer of the motion that something be done about band-planning. Perhaps an opposing motion will be brought in; there may be amendments—but in any case we do hope there will be lots of discussion. But, for the moment, for goodness' sake let us have a *proposal*. So here it is, all previous suggestions made editorially being cancelled.

### The Plan

Proposed (and seconded by the Editor) that the amateurs of Great Britain shall voluntarily submit to the division of their bands in the following manner:

- 1·7 mc
  - 1715-1800, CW only.
  - 1800-2000, 'Phone only.
- 3·5 mc
  - 3500-3635, CW only.
  - 3685-3800, 'Phone only.
- 7 mc
  - 7000-7050, CW only.
  - 7050-7150, 'Phone and CW.
  - 7150-7300, 'Phone only.
- 14 mc
  - 14000-14100, CW only.
  - 14100-14200, CW and 'Phone.
  - 14200-14400, 'Phone only.
- 28 mc
  - 28000-28150, CW only.
  - 28150-28500, 'Phone only.
  - 28500-29700, U.S.A. 'Phone only.

The 7 and 14 mc bands, with their proposed three-way division, may be rewritten to look like this:

- 7 mc
  - 7000-7150, CW.
  - 7050-7300, 'Phone.
- 14 mc
  - 1400-14200, CW.
  - 14100-14400, 'Phone.

Perhaps they look a little better like that! At any rate, distinctly more favourable to the 'phone user.

### Discussing Details

Now, before the cries of rage begin, let us make some explanations. First of all, the "top band." The LF part of this freed from 'phone may appear narrow, but traditionally it is largely a 'phone band, and many users of it as such would resent confinement at all. It so happens, however, that most of them started up when the LF end of the band began at 1800 kc and are therefore already on higher frequencies than that. Thus, they have the benefit of the band as it was

originally opened, and the CW operators have the newer part to themselves.

The 3.5 mc situation has been fully discussed (October issue, p. 488) and many letters of agreement have been received.\* This, therefore, hardly warrants any further expansion or explanation. The division in this case is ready-made and convenient, and if the 'phones happen to have a few kilocycles less than the CW's, well, that's too bad—but not really serious.

### 7 mc Division

Now for 7 mc. This is probably the most thorny problem of all. It is looked upon by most British amateurs as essentially a 'phone band, and yet so many of the newly-licensed amateurs, confined to CW, want to operate on it as their "testing-ground." The suggestion here is that 7000-7050 kc should be made *exclusive* to CW, and that in compensation for the fact that the band is so narrow, CW should also operate, but not exclusively, up to 7150 kc. After all, 25 watts of CW seldom cause serious interference to 150 watts of 'phone; but there are times when the presence of the 150 watts of 'phone will not be noticed on account of skip, and fairly short-distance CW QSO's will be possible without interference from it. The 'phone users therefore have also been given an "exclusive" 50 kc—from 7150 to 7200—and it is hoped that the BBC Chorus above 7200 will eventually move out.

The most important thing is to preserve the 7000-7050 slice as *absolutely exclusive* to CW. This means more than abstaining from working 'phone there yourself; it means an active part in trying to clear it, by working 'phones heard in that part of the band, explaining the plan, and asking them to move. A lot more of this could be done—the average amateur is rather too shy about asking others to do things, and only a very hard case is going to resent being asked to co-operate in a plan which is ultimately for his own good.

### Splitting 14 mc

The 14 mc band hardly presents a problem, except that if the U.S.A. 'phone band really *is* finally settled at 14200-14400 kc, we think it is too much.

But in this case the U.S.A. does not come in all day, and European 'phones can use the whole band from 14100-14400 kc instead of confining themselves to 14100-14200. The lower 100 kc for

CW only seems eminently reasonable, for 14 mc is one of the best, and certainly the most used, of the DX bands. 100 kc, if anything, is rather narrow, but then the CW can spread higher amongst the 'phone "at its own peril," as it has been doing very successfully for some time past.

### Ten Metres

The 28-mc band, strange to relate, has already settled down in practically the manner suggested. Obviously when you have a band 2000 kc wide there is not so much of a problem. You can afford to be generous and give three-quarters of it to U.S.A. 'phone, and still have ample room. Probably 80 per cent. of the total use of the band in this country consists of 'phone QSO's with the U.S.A., and thus it is in everyone's interest that the W stations should be given a space of their own; and no one in his senses is voluntarily going to put his own transmission *in* the American band.

The remaining 500 kc of 28 mc should be enough to accommodate the rest of the world on 'phone and CW, and the 150 kc at the bottom end for CW only is rather more than is regularly used at present by the CW men. Fortunately, the 'phone band can be populated by G stations and DX alike without a lot of mutual interference, as far as an observer in one particular place can judge. In this respect, 28 mc differs from all the other bands—even on 14 mc one or two Europeans thoughtlessly using 'phone in the CW area can make things extremely unpleasant, but it is only on rare occasions that short-skip conditions prevail on ten metres, and then it is rather interesting to hear them, anyway.

Well, there, at any rate, is a proposition. It has not been thrown off casually, but as the result of much first-hand experience with CW and 'phone on all the bands concerned, and of many discussions with other amateurs. There is nothing selfish about it whatever—it is believed to be a plan which could work for the greatest good to the largest number.

If you disagree violently with these proposals please write to us and say so; if you agree with it, then put it into action forthwith—as well as writing and saying so!—and *tell others* that you are adopting it. But in any case let us have some action, and not continued apathy, on the subject.

Ladies and Gentlemen, the proposer is about to sit down. If the motion is defeated, he wants his epitaph to be, "At least, he *did* try!"

\* And some since disagreeing.—Ed.

# DX COMMENTARY

## ON CALLS HEARD, WORKED & QSL'd

Your Commentator had a very nice Christmassy dream one morning late in December. He awoke to find one of those clear, "healthy" mornings, with white frost on the ground and a brilliant sunrise, wandered into the station and turned some heat on, and proceeded to look round . . . 7 mc! Sure enough, there were the W6's and W7's coming through beautifully, with a VE7 and a KL7 for full measure. Having savoured this for awhile, he wandered on to 14 mc, and, sure enough, there were ZL's, VK's and KL7's again—mostly S8 or better.

After an hour or so on these two bands, the 28 mc coils were removed from their lair, and there was 28 mc, full of S9 ZL 'phones, with VR2AA and VR2AB "parked in the cracks." When the pleasures of easy DX began to pall (and they do, you know), your dreamer pulled out the folder kept for readers' letters, and read off the first few headings: "Transatlantic Contact on 1.7; 1000 QSO's with New Zealand; Russian Prefix Puzzle Sorted Out." All too good to be true!

But the strange thing is that it was not a dream at all, and here we are, in a rather chilly shack, with at least three bands full of DX, but unable to do a thing about it because of writing your "DX Commentary." And first of all we will have the three letters mentioned.

### Transatlantic on 1.7 mc

G6MC (Bingley, Yorks), at 0220 on December 1, heard VO1NF calling CQ on 1800 kc. The VO was RST 559. After a call from G6MC he came back, giving him a 448 report and stating his QTH as "s.s. *Empire Brent*, 400 miles east of Halifax, N.S." G6MC's rig was 6V6-807 with 10 watts and Marconi aerial, 150 ft. E.-W. Very fine work, this; the VO was just as far as Newfoundland itself, so some of the land-based VO stations ought to be contacted this winter if they are working on 1.7 mc.

It is now our pleasure to report a record that will take a lot of beating. G5CP's famous Marathon with ZS1AX (more than 100 QSO's to date), splendid as it is, now fades out before this one: G5QA

By L. H. THOMAS, M.B.E. (G6QB)

(Exeter) has just completed 1,000 QSO's with ZL2OU on 14 mc! This has been the result of a daily sked begun in October, 1936; and if you like to count up the available days between then and now (for the 14 mc band was closed nearly seven years), you will discover that the sked has not missed fire many times. Congratulations to both stations! (Any challenges from some of you DX Kings?)

### The Russian Story

A certain amount of first-hand news has been acquired in QSO's with various parts of Russia and Siberia, and the prefix-cum-number story is now more or less clear. As we thought, the numbers are all that matter, and if you worry too much about the prefix letters you will merely get into a muddle. The numbers mean pretty well what they did before the war, as under:

- 1: Leningrad and District.
- 2: White Russia (Minsk, Smolensk, etc.).
- 3: Central (Moscow, etc.).
- 4: Volga (Kuibishev, etc.).
- 5: Ukraine (Kiev, etc.).
- 6: South Caucasus (Rostov-on-Don, Baku).
- 7: North Caucasus.
- 8: Turkomen (Tashkent).
- 9: Western Siberia (Sverdlovsk, Tomsk, etc.).
- ϕ: Eastern Siberia and Polar Regions.

For the new-country-lover we had better explain that in pre-war days the districts 1, 3, 4, 7 all counted together as one "country," with 2, 5, 6, 8, 9 and ϕ all counting as separate ones, and 8 divided into about four!

There is not much to add except that the prefixes apparently sub-divide these large areas. For instance, UA1 appears to mean Leningrad and UN1 something else; certainly UQ2 is Latvia, which has been "pinned on" to White Russia, UC2; UA6 is Rostov and UD6 Baku; on the other hand UAϕ means both Discon Island and Irkutsk! This all strengthens our advice to worry only about the figure—or why worry at all?



### No Grouses this Month

We had planned a return to the grouse-and-grievance department, but it is the wrong season for it. Everyone is still worried about the 'phone-versus-CW business, but we have made a contribution to that elsewhere in this issue. In any case that is one of the main issues that is always with us, and what is the use of grouching or grievancing about that when you (yes, *you*), dear reader, are the one that can put it right? We have no accurate figures on the number of British stations actually on the air, but we guarantee that if everyone reading these words at this moment could agree on some sort of a plan, the thing would settle itself.

#### 7 mc

The forty-fiends, who were after our blood two months ago, have quietened down, apparently satisfied with our soft words last month. Some of them have been doing some more nice work. G5GK (Burnley) wants to make it clear that his claims for first contacts with VO and YR last month referred to 'phone. Since then he was worked, on 'phone, W2 (4 contacts), W9 (1) and UG6 (2). Replies on CW, of course. 'GK has had 1000 'phone contacts on the band since September 21; and now he wants DX contacts with CW stations each morning between 0700 and 0800. Frequency is 7173 kc.

G2HLF (Heathfield, Sussex) has had a report from VK7 and is still knocking off the W's. He says OE4LA is genuine (QTH in box) and tells us that he worked YR5C on September 13—this may well be the first 7 mc QSO.

G2AUA (Wellingborough) has listened in 10-minute spells between 0715 and 0845 and has heard the following: All W districts except 7, NY4, VE, KH6 and ZL. One Sunday morning he heard a British 'phone complaining of QRM at 0845, and the speaker himself was QRM'd by VE3AJX on CW, S7! 'AUA mentions that G2VU, of Wellingborough, has just built a new transmitter and will shortly be on the air. He was first licensed in 1910—salute the old-timer! G6ZO (Totteridge) has worked nine or ten W6's on the band in the early mornings.

G2PQ (Dollis Hill) has also been reported from VK7 (our old friend Eric Trebilcock). This month 'PQ sails for Hong Kong; he will be there for three or five years, so look out for VS6PQ on 14 and 28 mc. Best wishes to him, and we'll be looking. G3HS (Faringdon)

worked VE2BV with 10 watts of 'phone at 1120! Duly verified, too.

A long and interesting letter from GM3AJX (John o' Groats) champions the 7 mc band and makes a number of criticisms. 'AJX, a commercial op., finds amateur procedure very long-winded, and is especially exasperated by stations that *will* send doubles when they are R5. All the usual "Very p' eased to work you," and so on, and the miles of "Mni trx QSO, hope cuagn," and all that, also bother him. Well, we have suggested "101" and "102," but no one seems to adopt them. Personally, we feel that anything making a QSO more of a rubber-stamp affair is to be deplored, but we do agree that if you added up all the time spent on sending things that the other fellow *knows* you will send without even bothering to listen, you would be surprised.

We imagine that this is a subject that could lead on to a good deal of debate, so let's have it. Let us adopt any procedure that will cut down the needless waste of time, without completely removing the personal-cum-amateur flavour from a QSO.

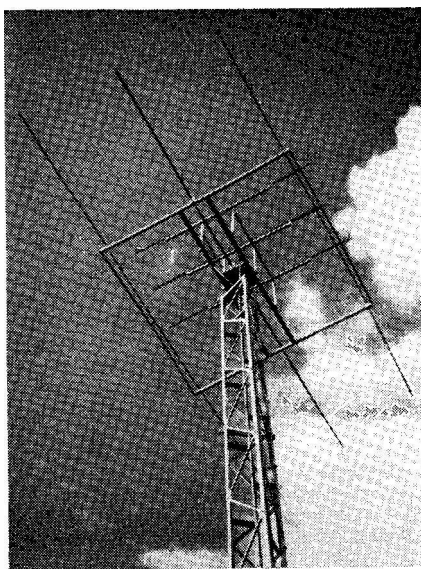

The very fine 5- and 10-metre rotary beam at G6JK, High Wycombe, Bucks. The 58 mc array is at right angles to that for 28 mc, and both use folded dipoles for the driven element, with one-tenth wave spacing and 72-ohm feeder. The 5-metre beam is 3-ft. above the 10-metre array. The height of the whole assembly is 33 ft.



The operating position at E18J, Dublin, licensed since February, 1936. A full description of this home-constructed installation will appear shortly in the "Other Man's Station" series.

Continuing GM3AJX's story, he has worked YI3GM (7150) and OX5JJ (7135), as well as W1, 2, 3, VE1, most Europeans, and UA1, UG6. His final comment is "A little less QRO working would help. I am licensed for 150 watts but find 30-40 ample to get around with. Confine the 150-watt boys to 7200-7300 and let them join the BBC chorus!" Once more, we agree.

### 3-5 mc

This band is becoming distinctly interesting. G2CYV (Brixton) has worked W1, 2, 3 and 8 with 20 watts (all between 0500 and 0700), as well as most of Europe. G6BY (Weston-super-Mare) has been having cross-band QSO's, using 7 mc himself and working the 3-5 mc W stations; one of his contacts (with W1DQ) was 100 per cent. for two hours. G2PU (Cambridge) claims the first post-war 'phone QSO with W on 3-5 mc. On December 2 he worked W1CPI, and afterwards worked W1DHD and W2RNM, as well as VE's and VO's. 'PU had R5, S8 from W and an S9 plus from VO2N. All very nice work; and who will claim the first post-war VK and ZL on this band? G6ZN (Horbury) has worked W3 with his 3-watt battery rig—very fine going.

### 28 mc

Our old friend appears to be very reliable this winter; there has not been a single fade-out during the month, but very long skip is making things rather difficult in the mornings sometimes. Stations

have been RST 289 on account of echo. Sometimes only the G's have it; on other mornings the VK's and ZL's are difficult to copy; and at least once, CR9AG (S9) had such a beauty that one could not hear any gaps in his keying at all! W6 and W7 are very reliable in the late afternoons, and there has been at least one "W7 party" with all of them coming over at S9 or better.

GM3ANV (Giffnock) has picked out G5K W/HZ (our wandering friend Ken Ellis of SUIKE), and also sends the QTH of PZIRM (in box). G5NF, in a convalescence centre at Alton, Hants, has been doing some splendid work with his bedside transmitter, working W's, VE's, VK's, XZ's and so on, all with his chalet-mate's broadcast receiver standing back to back with his TX, and operating all the time! G5NF is always glad of a call from near or far; he has a Comet-Pro and his transmitter is a little two-stager with 12 watts input. He is certainly using Amateur Radio under the most difficult conditions, but making the best possible use of it.

For the rest, 28 mc DX has been so commonplace that very few readers have bothered to report their doings. Judging by the number of 25-watters who have been heard making 'phone WAC's on the band, it will soon suffer a lack of popularity as being "too easy" . . . or will it? It will probably fade out again soon!

### 14 mc

This band never loses its attraction; one never knows what will turn up, and the new-country-chasers stick to it like glue. There are really two different kinds of DX-King—the one who specialises in ultra-reliable DX contacts maintained over a period, and the one with an infallible "nose" for something new and exciting. The former is adopting 28 mc and the latter, 14 mc. Certainly the amateur who works regularly on both bands cannot miss very much in the way of DX, but will sooner or later reach the state

where 7 and 3-5 present some very welcome novelties. But there we go—it will be the “specialist-v.-Jack-of-all-Trades” controversy again in a minute.

VU2AJ (Mhow) discloses that every Saturday at 1100 the boys out there have a QSO-party in which AC3SS and AC4YN frequently join. 'AJ also operates on 28 a lot, but wants reports on both frequencies.

G2PU (Cambridge) has worked VP2GB (Grenada) and YN1BF (Nicaragua), both on 'phone. G2VV (Hampton) has opened up from his new QTH with a new TX, and is doing well on 14 and 28. He comments on the terrific signals from Scotland that frequently arrive in Southern England on 14 mc—he gets S8 from GM on both hands.

G5LH (Horbury, Yorks) remarks on the good VK contacts possible at about 1900. He has also worked VP8AD, EPIAL, UA $\phi$ KAA and other nice pieces. G6ZN (Horbury) is doing well, too, and is building a rig for 14 mc.

G6BB (Streatham) has a 50-watt rig going now, and has been working VE4 and 5, ZS, ZC3BC (QTH given as British Army in Palestine) and other nice ones. He also passes along the QTH of T1NS, the owner of that T1/T4 note on about 14080. We worked him and collected his QTH the same day and it checks!

VU2AP (at Secunderabad) is now working 14 mc 'phone but has not found conditions too good. The only G heard at the time of writing was G6XR, but Bob sends some nice QTH's for the panel, and asks for reports from all and sundry who may hear his 14 mc signals. Harold Owen (Gold Coast) puts in a good 14 mc Calls Heard list. He is now deciding to drop 28 and specialise in 14. We would like to hear him on the air one day.

#### Miscellany

ZB2A (Gibraltar) continues to keep watch on 1.7 mc, without results as yet. He hopes to be more active on 14 before long, from his new QTH on the west side



G6NP, Heckmondwike, Yorks. One of the trio featured in “100 Years of Amateur Radio” in the September issue. The transmitter equipment is on the upper shelf and on the operating bench is an RME-69 with DB-20 pre-selector.

of the Rock. His list of stations worked on 28 seems to indicate that the new location is doing fine. . . . G6FW (St. Helens) tells us that Eric Sherlock, a friend of his from St. Helens, has been allotted the call VK2ANE; he is chief op. on the s.s. *Chertsey*, in Australian waters, and works mainly on 14 mc 'phone. QSL's via 134 Liverpool Road, St. Helens, Lancs. . . . G3BBL (Shilton, Oxon) suggests that a certain type of operator we all know should be dubbed a “Handler.” ‘BBL says “Heard a solid 20 minutes of drivel from one of those bods with some person named Pearl, or something; so keen on nattering, he wasn't interested in a proper report, just a better one than some other equally clueless and selfish ‘Handler.’” From which we conclude that G3BBL did not like him much! . . . S/L Pain, late of ZB2A, now G3ATH, is off on his travels again, this time to Rangoon. He is taking a 6L6-807 rig with him and hopes to get on the air very quickly on 28 and 14. Reports and QSO's wanted.

Several correspondents bring up the subject of the poor percentage of QSL's that come back. Do they go astray, or is it just that the other chap doesn't bother? We should say its a little of both. There are amateurs who ask for a QSL and have no intention of sending one; there are those who get in such a muddle that they don't know whether they have sent one or not; there are some who ignore all the rules, send them to old QTH's, get them lost in the post; and there are

## DX QTH'S

CN8BA	Le Cret, Rabat, French Morocco.
EK1MD	Milton Ramsey, Radio International, 34 Rue Goya, Tangier.
EL5B	Mike Cywan, APO 194, P'master, N.Y.C.
FG3FP	PAA, Dakar, French West Africa (or APO 194, P'master, N.Y.C.).
HS1SS	US Army, 141 A.C.S. Sqdn., Detachment HQ, Bangkok, Siam.
KH6GF	Kailua, Oahu, Hawaii.
KP6AB	Palmyra Island—c/o Fleet Post Office, San Francisco, Calif.
J3HRP	Signal Corps, Kyoto, Japan (APO 301, P'master, San Francisco).
J9AGT	APO 239, P'master, San Francisco.
LUIZX	Yacht <i>Gaucha</i> , c/o Radio Club of Argentina, Buenos Aires.
OE4LA	c/o Mangold-Huber, Klybeckstr. 230, Basle, Switzerland.
OX5JJ	Danish Weather Station, Cape Adelaer, Greenland.
OQ5BT	Randour, Telecoms, Stanleyville, Belgian Congo.
PK4RI	H. B. Venhuyzen, Signals, Y Brigade, Palembang, Sumatra.
PZ1RM	Box 118, Paramaribo, Surinam.
SHF1	Chalmers, University of Technology, Gothenburg, Sweden.
VO2D	Phil Gugliotta, Fort Pepperell, St. Johns, Newfoundland.
VS1AC	Singapore Line of Communication Signals, SEAC.
VU2AP	Lt. R. S. Craig, 2/10 Gurkha Rifles, Secunderabad, Hyderabad.
W3KIF/MM	U.S. Tanker <i>White Falcon</i> , 100 Montgomery Avenue, Bala, Pa.
W7QI/KL7	Box 307, Anchorage, Alaska.
W8SIR/VP9	Lt. Dave Fugman, APO 856, P'master, N.Y.C.
XZ2LR	No. 2 FEU, RAF, SEAAF.
XZ2YT	RAF Sigs Centre, Rangoon, SEAAF.
YIIT	RAF Shaibah, British Forces in Iraq.
YP1AA	c/o Messrs. Ashman, Minerva Club, 28A Brunswick Square, W.1.

also people who just don't take the slightest interest in the whole QSL racket, and do not even possess cards! But the rarer QSO's seem to yield pretty well. Your Commentator has had 75 QSO's with W6, and only 24 cards back; on the other hand 25 QSO's with W7 have yielded 23 cards. This must be because W7's are not able to work Europe nearly as frequently as do W6's; some of their cards came direct by Air Mail. VK's show a very poor return (13 cards for over 80 QSO's), but we know they take a tremendous time these days. On the whole our feeling is that QSL's are a darn nuisance, but rather nice!

## Competitive Dept.

We don't have many claims in these days for "WAS," "DXCC," or what have you. Can it be that the country-counters are growing stale, or blasé, or both? Since there is so much ambiguity about what is, or is not, a new country, we should very much like to clean the matter up; but it is no good starting another system, because there is already a "WAZ" (Worked all Zones) from one source. It is a suggestion worth considering that one should count each different *prefix* as a different "unit." In other words VE1, VE2, VE3, and so on, all count as a "unit," worked; but then, to be logical, we should have to include G2, G3, G4 and the whole lot, together with other countries in which a different figure does not mean a different district.

So what do you think is wanted as a DX yard-stick—(i) Political boundaries; (ii) artificially-made "zones"; (iii) Prefixes-and-figures; or (iv) Letter Prefixes *only*? Or does it matter, anyway? You work some very nice DX, and so does the other fellow with a tenth of your power. If one of you is "better" than the other, who worries about it? It's a hobby, not a life-long competition.

Acknowledgments and thanks to all correspondents, and very best wishes for a splendid year of DX. Keep it clean!

*Transmitting readers are invited to send items for DX Commentary to L. H. Thomas, G6QB, "The Short Wave Magazine," 49 Victoria Street, London, S.W.1., to reach him as early as possible in the month. SWL reports are only included in DX Commentary if they are of direct interest to transmitters.*

# CALLS HEARD

Please arrange all logs strictly in the form given here, in numerical and alphabetical order and on separate sheets under appropriate headings, with call sign and address on each sheet.

## OVERSEAS

### 14 mc

Harold Owen, B.Sc., West African Cacao Research Institute, Tafo, Gold Coast Colony.

CW: G2ADC (33), 2AHP (55), 2BQC (55), 2CBA (54), 2CIX (56), 2CKR (55), 2COP (55), 2DZ (54), 2FLC (45), 2FMT (43), 2FJSJ (34), 2HFO (458), 2HX (56), 2IM (558), 2JT (43), 2KO (55), 2LC (44), 2LU (54), 2OC (55), 2SY (54), 2TK (33), 2XV (55), 2ZA (43), 3AAK (54), 3AHY (566), 3APK (458), 3FC (55), 3IH (45), 3KP (56), 3LL (446), 3WA (55), 3XD (55), 4GI (45), 4GX (438), 4KI (55), 4KS (55), 4NS (44), 4PR (56), 5CV (55), 5DQ (55), 5GT (55), 5LH (44), 5LI (56), 5MY (54), 5OJ (55), 5VB (557), 5WI (54), 5YU (45), 6BB (54), 6BQ (55), 6BS (54), 6CJ (56), 6FG (55), 6GN (54), 6JF (44), 6KP (558), 6QN (55), 6RB (44), 6UA (56), 6UT (55), 6XX (56), 8AC (55), 8BD (54), 8DL (44), 8GO (44), 8HH

(44), 8IG (56), 8II (56), 8PL (45), 8PO (55), 8QZ (56), 8TC (44), 8TK (45), 8UT (558), G15NJ (55), GM2DI (34), 3PK (558), 3XB (56), GW3ZV (568). Nov. 1-Nov. 21. (RS values in brackets: Receiver, 0-V-1.)

### 3.5 mc

Alois Weirauch, OK1AW, Mestec Kralove 9, Czechoslovakia.  
G2AVW, 3AKA, 3HS, 3JZ, 5MU, 6YL, G16TM, GM3AJZ, 6MY.

### 1.7 mc

Alois Weirauch, OK1AW, Mestec Kralove 9, Czechoslovakia.

G2FWA, 2YH, 3AEX, 3AFT, 3ASR/A, 3IP, 3LP, 3NN, 3SU, 5RI, 6RS, 6VC, 8JM, 8QZ (November 16.)

G3AWR, aboard s.s. Alt at Ghent, Belgium. Home address: 37 Torrington Road, Greenford, Middlesex.  
CW: G2AFM (55), 2AFO (55), 2AJH (55), 2AUF (55), 2BCX,

(56), 2BMN (55), 2BRH (44), 2BTO (44), 2CNW (56), 2CPF (57), 2CPL (56), 2CUI (57), 2FGU (56), 2FLK (57), 2FPU (44), 2FO (55), 2FWA (55), 2FZR (58), 2HCO (56), 2HIL (58), 2HNU (55), 2IF (55), 2IJ (55), 2JN (45), 2SU (55), 2YH (56), 2YS (56), 2YV (56), 3ADJ (56), 3AFT (58), 3AGU (56), 3AIL (55), 3AJD (55), 3AJO (56), 3ALK (34), 3AMI (45), 3AMW (55), 3ANM (56), 3ARD (44), 3ASR/A (55), 3ATD (44), 3AUC (44), 3AWM (36), 3GA (55), 3IP (44), 3JO (56), 3KP (56), 3LP (56), 3MV (56), 3NN (44), 3XV (55), 4GT (44), 4JB (56), 4NH (44), 5DZ (55), 5FN (45), 5OH (56), 5PA (46), 5RI (55), 5SU (56), 5WV (57), 6AK (56), 6GM (56), 6HD (55), 6KR (55), 6KU (56), 6NN (55), 6RO (35), 6RS (57), 6SS (56), 6ST (55), 6VC (56), 6WF (56), 6ZN (45), 8BM (34), 8DV (44), 8GG (56), 8JR (44), 8KU (55), 8LG (56), 8NM (44), 8SG (57), 8US (56), 8VN (55), GM2FZT (45), GW3AJ (55). (November 16 and 17.)

### 7 mc

XABC, H.O. Unit, 244 Wing, RAF, CMF (Austria).

Phone: D2AV, 2DA, 2GO, 2KW, 2SP, 2SW, G2DYM, 2DYV, 2HMK, 3BR, 3KS, 5FA, 5GK, 5NL, 6OF, 8BW, 8KN, 8ML, 8QX, G15ZY, GW4NZ, PAØFB, ØMM.

## DX FORECAST FOR JANUARY 1947 (All time GMT)

	7 mc	14 mc	28 mc
<b>NORTH AMERICA :</b>			
East and Central .. .. .	2200-0830	1400-0900	1130-1630
West Coast .. .. .	0600-0800	1500-1800	1500-1700
<b>CENTRAL AND SOUTH AMERICA :</b>	2300-0500	2100-0700	0900-2000
<b>AFRICA :</b>			
North of Cancer .. .. .	All day	All day	0900-1500
South of Cancer .. .. .	1800-2200	1500-2200	0900-2000
<b>ASIA :</b>			
West of 75°E. .. .. .	?	All day	0800-1100
East of 75°E. .. .. .	?	1300-1700	0830-1200
<b>OCEANIA :</b>			
VK and ZL .. .. .	0600-0900	{ 0800-1100 1800-2000	0930-1300
PK, KA, VS1, etc. .. .. .	?	{ 1300-1700	0900-1200

NOTE.—The times given above are the most likely periods during which signals may be expected from the parts of the world indicated. Under unusual conditions, signals may be heard outside these times.

# First Class Operators' Club

## Policy—First Membership List

Once again, we are glad to record a healthy interest in the affairs of the F.O.C. For those who may not have seen the earlier announcements in the *Magazine*, there are several points to make clear.

### History

The first is that the F.O.C. as re-constituted is a revival of the pre-war formation, of which the late R. B. Webster, G5BW of Eastbourne, was secretary and organiser. Just before the war, the Editor was asked by him, on behalf of the then Committee, if space could be made available in the *Short Wave Magazine* for the appearance of regular notes. In view of the objectives of the F.O.C., this was readily agreed.

A preliminary announcement to this effect was accordingly made in the September, 1939, issue of the *Magazine*—the last before the war. At that time, the F.O.C. had 70 members, the president being the late John Hunter, G2ZQ.

With the post-war resumption of amateur activity, the possibility of reviving the F.O.C. was put forward from several quarters. The original moving spirits having passed on, the first problem was one of finding a new secretary-organiser if (depending upon the support to be expected) the Club was to be revived at all.

It was agreed that the *Short Wave Magazine*—whose sole interest in the F.O.C. is that it should be a properly constituted organisation, run by and for its members—would re-assume its old commitment to the Club. It was also arranged that the revival of the F.O.C. should in its early stages be guided by A. M. H. Fergus, G2ZC, one of our oldest readers, who undertook the always rather thankless task of secretary-treasurer and organiser until such time as a new Committee could be elected and rules of procedure agreed.

### F.O.C. a Craft

The announcement of the re-constituted F.O.C. made, as its very first point, on page 562 of the November issue of the *Magazine*, that the Club is not a "snob society"—all it wants is the support of operators of any sex, age, seniority and experience who accept and can conform

to the standard set by the provisional rules—see p.623, December issue. As to the comment that the F.O.C. might be an "upstage party," the answer is that it is the first time we have heard the suggestion that because someone thinks he can do something well, he is a snob if he associates himself with others who can also do that same thing as well as he can! Put in another way, the F.O.C. is no more than a craft foundation, just like any other organisation of craftsmen.

From the point of view of the *Magazine*, the whole business of providing free space, stationery and so on is entirely a labour of love in the general interest. In the nature of things, F.O.C. membership is never likely to be large, the Club has complete control over its own small funds (amounting anyway to no more than a few shillings to cover postages) and, believe it or not, nobody has any axe to grind at all! Those concerning themselves with the function and organisation of the F.O.C. have many years of the tradition and experience of Amateur Radio behind them, and are solely concerned that the Club should be successful in making its own small contribution to the art of the general good.

### Membership Election

In accordance with the rules, the following are declared active F.O.C. members on the current list:

R. Postill, Jersey (GC8NO); F. W. Fisher, Norwich (G3VM); Cmdr. G. C. Turner, R.N., Sevenoaks (G5IH); Capt. W. H. Windle, Dartford (G8VG); Capt. R. L. Varney, Chelmsford (G5RV); J. N. Roe, Hampton-on-Thames (G2VV); B. Pashley, Sheffield (G6PJ), and D. Mitchell, Colwyn Bay (GW6AA).

### Ex-F.O.C. Members

Beyond the announcements in the pre-war issues of the *Short Wave Magazine*, no records or membership lists of the 1939 F.O.C. are known to exist. Ex-members are therefore invited to renew contact as soon as possible by writing to Capt. A. M. H. Fergus, G2ZC, 89 West Street, Farnham, Surrey, to whom all correspondence regarding the F.O.C. should be directed.

# Meteor Reflection on VHF

Notes on Interesting Observations

By HILTON O'HEFFERNAN (G5BY)

*(It now appears to be an established fact that VHF signals are, at times, returned to earth by meteors entering our atmosphere.—Ed.)*

Ever since the writer commenced his over-150-mile contacts on the 58 mc band last April, he has been puzzled and intrigued by what was christened, for want of a better term, the "ping" effect. This can be described briefly as follows: On a signal running normally S4-5, with perhaps an occasional peak to S6 and a drop to S3, there would suddenly occur an enormous increase in signal strength—estimated to be between 10 and 20 dB on the average—lasting for about the duration of a Morse dash at a sending speed of 12-15 w.p.m.

This effect has been observed over and over again during 58 mc contacts, particularly on the signals of G5MA and G6LK. Due to the lack of AVC, it is naturally more noticeable on CW than on telephony, although it has been observed on the speech from G6LK and a few other stations.

No previous comment on this phenomenon has been made, save to G2DYM (who has observed the effect himself at G5BY), Dr. Robinson of the Institution of Radio Engineers, and G3PZ, who visited G5BY on July 23 when ten over-150-mile contacts were made.

## Results in America

A reference to the subject in November *QST*\* interested the writer greatly, and during a solid one-hour telephony contact on 28 mc with WIHDQ of *QST*, some further information was obtained regarding the effect.

During the war, the Federal Communications Commission (FCC) wanted to know, for planning purposes, the extreme range of the FM stations operating in the VHF band.

Accordingly, receivers were set up at distances up to 1,400 miles, to record on certain selected FM stations, radiating normal programmes.

\* A letter from W2LXX relating what have become known as "meteor howls" with unusual reception in the American 144 mc band, of the type described by G5BY.—Ed.

Normally, many of these stations were inaudible, yet the recording receiver periodically logged bursts of programme, at tremendous strength, and scientific opinion in the States now definitely ascribes these results as being due to the passage of meteors in the earth's atmosphere.

Convincing corroboration of this theory was recently obtained when Zinner's Giacobini was due to pass near the earth, when a stream of meteors would enter our atmosphere. According to WIHDQ, this occurred at about 2100-2200 EST during an evening when, up to that time, conditions for VHF working had been poor. No temperature inversion was present nor was sporadic-E observed.

At the exact time predicted for the passage of the meteors, the entire 50 mc band became filled with signals from, it is understood, distances up to 1,400 miles, with no skip effect whatever. As one would expect, due to the intermittent nature of the signals, CW working was impossible, but by speaking slowly and distinctly, speech communication succeeded, and one of the best 50 mc DX sessions ever known in America resulted.

The writer is now extremely sorry that he had not had sufficient faith in his own original theory to spend that night on 58 mc (and to have induced G6LK to do the same!). The effect here would have occurred, presumably, between about 0200 and 0300 GMT.†

## Further Observations

Many other 58 mc operators must have observed these effects, and the author would be grateful for as much information as possible. A note of the facts above has been sent to the Astronomer Royal at Greenwich Observatory, and it is hoped that it will result in some useful and interesting work on this interesting but little known phenomenon.

† We are informed by the Royal Observatory that the peak display was at 0400 on October 10.—Ed.

# Break-In Operating Procedure

*What it is and How to use it*

By A. M. H. FERGUS (G2ZC)

*[Many of our more recently-licensed readers will find this article both helpful and stimulating. BK, properly used, not only tends to relieve congestion but also increases the satisfaction obtained from a snappy contact with a good operator.—Ed.]*

**A**LTHOUGH Break-In has been covered in articles dealing with transmitter design, not much has been said about the practical operation of the system, in the sense of the procedure to adopt. With an experience covering twenty years on the air, the writer offers the following notes to those who may be contemplating using CW break-in (or to give it the shorter title, BK) under actual operating conditions. Amateur stations use their own plain-language procedure when working a contact, but if they use BK, certain defined lines must be followed to obtain a commonly understood standard.

## Advantages

When properly operated, BK has everything to commend it. It allows working to be snappier; when QRM is bad, it cuts down unnecessary repeats, which in themselves can be obliterated using the normal method of transmission; and by saving time and ether space it helps to reduce interference. If any query arises during transmission, the receiving station can stop the sender on a word or even on a letter.

## General Procedure

In operation it is important to indicate that you can work BK, so in making a CQ or an initial call to another station, use the BK sign, which in Morse consists of the letters "B" and "K" sent as one group. Typical examples would be "CQ de G2ZC BK" or "G9BF de G2ZC BK." (No apology is offered for borrowing the call-sign of this famous station as an illustration!). That is all that is necessary to tell others that you are equipped to use BK.

If G9BF can also use BK, he will indicate this to you in his initial call by sending "G2ZC de G9BF BK."\* The moment you get that invitation, then BK him at once, by sending "BK," or a series of dots on the key. This method should always be employed when a transmission has to be stopped, and while it is a matter of taste which signal is used, the shorter is at all times preferable in everything pertaining to BK operation, so long as clarity of intention is apparent.

## Retuning

If, for any reason, you wish to retune your own receiver during a transmission, stop the other station, and ask him to send a series of V's. All that need be sent is "QSV," and he can reply either with V's, or by the normal call-up procedure using call signs. Once you have retuned him to maximum readability, stop him with a few dots, and send "GA" (go ahead), or "K." Creep or QRM are cases where a retune is often indicated. If reception is difficult due to a type of QRM that you think will be of short duration, stop the sending station, always explaining why you have stopped him (QRM), and if you wish him to wait a little, send "AS." This should be acknowledged back to show that the message has been understood; "R" or "AS" is quite sufficient, but stress must be laid on the importance of acknowledgment at all times, as this leaves no element of doubt at either end.

If the interference appears to be of a type that may continue (a long CQ call), then it is best to tell the sender

(\*What would actually happen if G9BF started to work break-in is, of course, quite another matter!—Ed.).



that you will continue transmission in the meanwhile till the interference ceases.

To tell him this, all that will be necessary is to send "QRM AS hr GA," and you then transmit till you hear the QRM stop; having completed your own sentence, tell the other station that the coast is now clear and will he continue. "Nw u GA" or even just "GA" will be sufficient to convey this. Keep things brief by avoiding long explanations, especially when QRM is prevalent.

### Repeats

The use of the interrogation sign (IMI) is the quickest way of asking for any type of repeat. Consider a case where a signal report has been missed. The correct procedure would be to stop the sender and simply send him "IMI RST" (repeat RST), just as "IMI AA" (repeat all after) or "IMI BN" (repeat all between) are useful things to remember, for it sometimes happens that a station may not hear your attempts to stop him right away.

Where a station is really lost, use of the QSV procedure, as already described, should be employed. Then there are the QSY, QSW and QSU procedures, covering a move of frequency which, though appearing complicated in theory, are perfectly easy in practice.

QSY means "change frequency" or "change frequency to . . . kc." For instance, when in contact with a station complaining of interference, "QSY IMI" would mean "Shall I change frequency?" to which his answer might be "QSU 3525" meaning "Change your frequency to 3525 kc." Similarly, on the other station remarking that QRM was bad, the reply could be "QSW 3525," meaning "I am changing to 3525 kc."

This example illustrates the finer shades of meaning of QSU and QSW. In amateur operation, it would be quite permissible to use QSY to cover all questions and answers relative to a change of frequency.

### Contacts

An important point to remember is

the use of your call-sign, not only to comply with the GPO regulations, but also to give an indication of identity to other stations who may be waiting to work either end at the conclusion of the QSO. This is best done at the start and completion of each long message, where you would normally go over to the other station; he, in his turn in starting up, will also use the ordinary call-up procedure.

In between call-up periods, where BK has to be used, unnecessary calls are to be avoided. But it can be exasperating if one has to wait for a BK operator, whom one would like to work, to disclose his identity; it often happens, however, that when one end of a BK QSO has been identified, the other end can be found. If at the conclusion of the QSO one station closes down and the other is ready to work someone else, he can be called up straight away. Remember to show him, by use of the BK sign while calling, that you are ready to work him the moment he BK's.

A station about to search the band after finishing a QSO should show this intention by sending, after his final VA to the station just worked, "Nw CQ de G2ZC BK K." Some operators use QRZ ? meaning "Who is calling me ?" for the same purpose.

One useful hint here: When calling a station who has just finished a contact and whom you know is searching the band, do not give long calls. Send his call-sign thrice, "de" once, and your own call-sign once (if sent really clearly), then "BK," and repeat till he BK's you, starts a fresh "CQ," or sufficient time is given to indicate that he has not heard you.

One tremendous advantage in working break-in is that if when calling a station he starts to call someone else, you can stop sending at once, as it is obvious he has not heard you. At this point, search the band, as some other station hearing you calling and then stopping without having made a contact, may in turn call you. He in turn should send his BK, so that you can stop him the moment you find him.

## NEW QTH's

Only those which have changed since the appearance of the September, 1939, issue of the Call Book or were not included in it for fully licensed operation, or are now licensed for the first time, can be published here. All that do appear in this column will automatically be included in the next Call Book, now in preparation. The number of QTH's we can print each month depends upon space available. QTHs are inserted as they are received, up to the limit of the space allowance. Please write clearly and address to QTH Section.

- G2AUR P. H. D. Rattle, 36 Heathcroft, Hampstead Way, London, N.W.11.
- G2BMC J. E. Church, 10 The Lodge, Linthwaite, Huddersfield, Yorks.
- GM2BWF E. D. Fleming, 4a Newton Terrace, Glasgow, C.3.
- G2CBA W. B. N. Althorp, 85 Copperfield Road, Rochester, Kent.
- GM2DAU E. G. Gamble, The Loans, Westfield Road, Cupar, Fife.
- G2DVA D. R. Bradley, Hope Farm, Halegate Road, Halebank, Widnes, Lancs.
- G2FAB D. H. Garrad, 7c Macaulay Road, Clapham, London, S.W.4.
- G2FZI F. Hill, Dingley, 997 Oxford Road, Tilehurst-on-Thames, Reading, Berks. (Tel.: Tilehurst 67556.)
- G2HKA A. Grundy, 4 Hildebrand Road, Liverpool 4.
- G2HKA/A A. Grundy, Berwyn, Runshaw Lane, Euxton, Nr. Chorley, Lancs.
- G2JN J. G. Stonestreet, Bossingham Street, Nr. Canterbury, Kent.
- G3AIS D. A. Smith, Three Oaks, 1 New House Chase, New Malden, Surrey.
- GM3AKM L. R. Richardson, 1 Wardieburn Place East, Edinburgh, 5.
- GW3ALX B. D. Davies, Overbridge, Murton, Swansea, Glam.
- GI3AMY J. T. Collett, 72 Brandon Parade, Sydenham, Belfast, N.I.
- G3AOL F. W. Ellis, 195 Sutton Road, Hull, Yorks.
- G3AOX T. K. Lord, No. 4 Flat, 13 The Cross, Oswestry, Salop.
- G3APK N. J. Hanscomb, 80 Manor Road, Kenton, Harrow, Middx.
- G3ATD J. J. Burchell, 4 Kangley Bridge Road, Lower Sydenham, London, S.E.26.
- G3ATH S/L H. Pain (ex-ZB2A), 6 Granville Street, Skipton, Yorks.
- GM3ATN M. K. Williamson, 94 Braid Road, Edinburgh. (Tel.: Edinburgh 55660.)
- G3ATW N. W. Hoare, 6 Chatsworth Road, Bitterne, Southampton.
- G3AUG E. L. Boxcer, 73 Northwood Avenue, Elm Park, Romford, Essex.
- G3AVJ E. J. Fox, 68 Almonds Green, West Derby, Liverpool, 12.
- G3AVL R. Reynolds, 43 Pendennis Street, Anfield, Liverpool, 6.
- GI3AWX J. Harbison, 33 Meadowbank Street, Lisburn Road, Belfast, N.I. (Tel.: Belfast 67338.)
- G3AXN G. Collop, 34 Christchurch Road, Southend-on-Sea, Essex.
- GM3AXO A. Burt, 8 Guthrie Crescent, Markinch, Fife.
- GM3AXX A. M. Fraser, 130 West Graham Street, Glasgow, C.4.
- G3AYE G. Wildig, 52 Wote Street, Basingstoke, Hants.
- G3AYL G. R. Pearce, 102 Kingshill Road, Swindon, Wilts.
- G3AZA D. M. Lewis, Sussex House, High Street, Portishead, Bristol.
- G3AZB K. F. Hayward, 29 Ardrossan Gardens, Worcester Park, Surrey. (Tel.: Derwent 5544.)
- G3AZC J. Grant, 37 Rectory Road, Felling, Gateshead 10, Co. Durham.
- G3AZF M. Illidge, 181 Oakfield Road, Anfield, Liverpool 4.
- G3AZH F. M. Moore, B.Sc., 10 Northumberland Avenue, Berwick-on-Tweed.
- G3AZT C. H. Walker, Singletree, 20 Eynsham Road, Botley, Oxford.
- G3AZZ B. W. Blackmore, 17 Alexandra Road, Bridgwater, Somerset.
- G3BAA A. H. S. Bridgman, B.Sc., Kingston, Kingswinford, Nr. Brierley Hill, Staffs.
- G3BBL E. J. S. Otter, 85 Southbourne Grove, Westcliff-on-Sea, Essex.
- G3BBQ N. Turner, 288 Plymouth Road, Plymouth, Devon.
- GW3BCG A. S. Beach, Awelon, The Maudlins, Tenby, Pems.
- GM3BCL A. G. Anderson, B.Sc., 87 Braemar Place, Aberdeen.
- G3KW S. E. Newby, Carina, Romney Road, Rottingdean, Sussex.
- G3TH G. L. Impey, 13a Drummond Road, Bournemouth, Hants.
- G4QU F. C. Mason, Cornerways, Bathurst Walk, Iver, Bucks.
- G5QI W. S. Carter, Chiltern Cottage, Lower Assendon, Henley-on-Thames.
- G5SP R. W. Spink, No. 1 Gardens Court, Avenue Road, Bournemouth, Hants.
- G6C1 B. W. Warren, 1 Crackley Crescent, Kenilworth, Warks.
- G8DH A. D. McKenzie, 48 Finchley Road Westcliff-on-Sea, Essex. (Tel.: Southend 2011.)
- GW8SU E. C. Bath, Hill View, Newton-Nottage Road, Newton, Porthcawl, Glam.
- G8VQ W. N. Guasley, 109 Hindes Road, Harrow, Middx.

# Home-Made Relays

Simple, Practical and Inexpensive

By N. P. SPOONER (G2NS)

The mention of "relays" with their supposed complications should not deter any amateur from considering seriously their construction and inclusion, wherever useful, in his station lay-out. Unlike the domestic problem, the services of these sturdy maids-of-all-work can be easily secured by slightly altering old car cut-outs. The prices may vary with the district, but as a guide the writer would mention that he has always been able to obtain them from a local car dump and scrap yard, where he has no "influence," for ninepence and one shilling each.

No tedious re-winding is necessary, and the actual alteration is the removal of an outer heavy-gauge winding, the extending and insulating of the contacts, the weakening of the armature tension-spring and a re-assembly on a new ebonite or wood base with two DC input terminals and two contact terminals.

## Modifying the Cut-out

Starting upon one cut-out, the armature tension-spring is first removed by prising open the top turn and slipping the spring out of its gripping groove at the end of the armature. The armature itself can then be lifted straight off after cutting its contact connecting wire. The shaped metal piece holding the moving contact is then removed by filing down the rivets and its place is taken by a small extension piece of paxolin or ebonite using a rivet hole for bolting through. The purpose of this insulating material is to allow the passage of heavy current through the contacts if necessary and to avoid any electrical breakdown between contact, armature, coil winding and metal frame.

The frame and coil can next be dismantled and the outer winding of heavy-gauge wire removed, as it is not wanted. This now leaves an inner winding of between 50 and 100 ohms resistance which will place no excessive drain on any 4- or 6-volt charger used as an energising source.

Before re-assembling the coil and frame on its new wood or ebonite base, the metal upright holding the fixed contact should be removed from the frame by filing the rivet heads. The frame and coil can then be fixed on the new base and the armature replaced in position without its tension-spring. The metal upright hold-

ing the fixed contact is now bolted to an additional upright of insulating material or wood that has been cut ready for the purpose. This is also fixed to the base in such a position that the face of the armature moving contact sits squarely on that of the fixed contact.

## Tensioning the Armature

Before replacing the spring its tension is weakened as much as possible by cutting off turns and stretching. The weaker the tension, the less current needed to attract the armature. The upward travel of the armature can be conveniently determined by arranging for it to hit against a piece of bent heavy-gauge wire. To complete the job, the two DC input terminals are mounted on the base and connected to the two ends

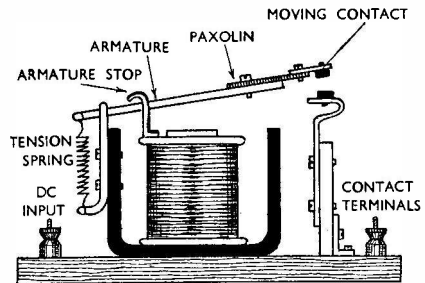

Arrangement devised by G2NS.  
A car cut-out adapted for relay working

of the coil. Two other terminals connect to the contacts, a portion of that going to the moving armature contact being flexible in order not to hamper the free movement of the armature.

## Adding Contacts

This completes one relay, and if multi-purpose relays for several combined switching operations are required, the necessary number of moving contacts can be secured from other cut-outs. Should the individual contacts alone be wanted, these can be removed from their metal fixings by gently filing round their burred-over stems and lightly tapping them away from the metal with a punch or the tang end of a small file.

No difficulty should be experienced in adapting old cut-outs as make, break, make-break and change-over relays.

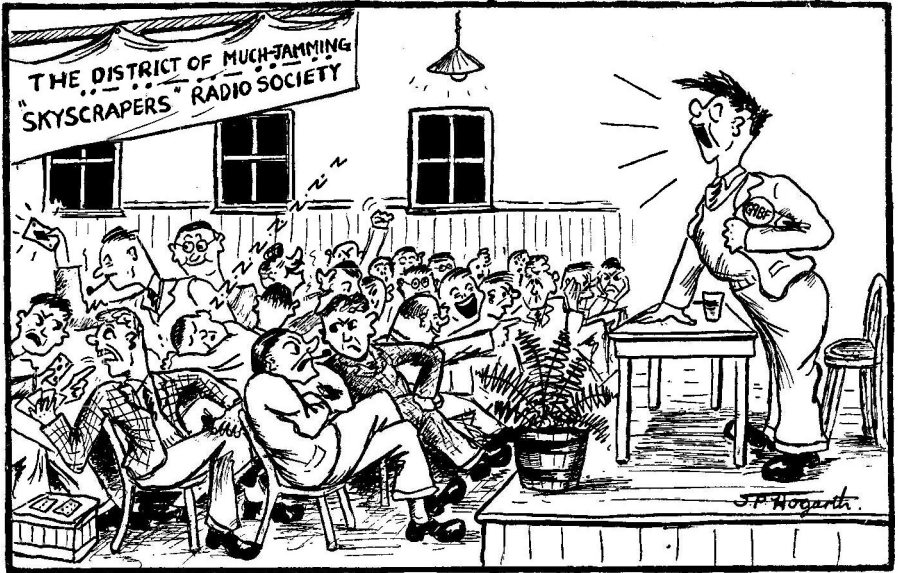

“ ————— FOR WHICH I AM FAMOUS ”

## G9BF Calling

(Can't get rid of the fellow yet.—Ed.)

Due unco-operative attitude Editor am unable disclose details design my hush-job mixer-plusser-subtractor-oscillator for obtaining several freqs simultaneously into PA grid.

Have had slight trouble obtaining expected results but idea obviously there and only matter of half-hour's work when I have time to astonish world Amateur Radio with constructional data.

Am now being pestered to reveal information my DX aerial. Have already said do not believe in *designing* aerial for DX; prefer to work to usual G9BF method of generating max RF power a hot end aerial and leave rest to nature. This policy proved right by startling DX record, for which I am famous, of station KZ7LX. This of course is me G9BF.

My aerial for all bands (use only 7 and 14 megs as am solely concerned European DX) consists of 25 ft. No. 24 DCC (to keep copper shiny) held up by strings between shack window and post in garden. Clever part my aerial is that when string wet *effective length* aerial increased since do not bother with insulators between

wire and strings; wire is slightly insulated anyway. Idea is to save wire, of course. In prevailing weather aerial always at max effective length of 66 ft. Feeder system is acme simplicity and efficiency (always advise try it the easy way first). Single length flex tapped to centre of 66-foot roof. Have been careful make good soldered joint at tap in order obtain maximum conductivity. This important point for beginners to note.

Have been unable as yet plot polar diagram this system but can say that sometimes get RF glow one end of wire and sometimes at other. On one occasion got distinct glow at tapping point when input to T20 running around 200 watts. Do not however recommend this procedure due danger over-loading T20.

Many famous DX callsigns consistently worked with this system, as reported in these pages during last nine months. No trouble at all bringing back rare stuff like BU1EGG, ACMAINS, MO1FFI, PX9YL, ZY5UU and unknown station signing SUSIE.

(Another page wasted.—Ed.)

# Here and There

## England-South Africa Flight

About the middle of this month, the D.H. Rapide GAHIA will leave Croydon for a trip to Africa lasting approximately eight weeks. Two-way amateur working will be welcomed, and the operating schedule is as follows:

**Transmission:** 8885 kc, hour plus 5 mins.; 6500 kc, hour plus 15 mins.; 4195 kc, hour plus 25 mins.

**Reception:** 14 mc amateur band, hour plus 10 mins.; 7 mc, hour plus 20 mins.; 3.5 mc, hour plus 30 mins.

The watch-keeping period will be 0800-1300 GMT, while the aircraft is in flight—which, of course, will not be every day. At the times and on the frequencies given, the operator will call QS1, sign GAHIA, and give position, time of departure last stop, and destination, followed by any message. He will then listen on the appropriate amateur band for calls. If an amateur contact is made, then the remainder of the schedule will be broken till the next watch-keeping hour. If no contact is made, then the next band will be tried.

Any message received, or contact made, should be reported immediately to Chief Radio Officer, CROydon 0581. Telephone charges will be reimbursed.

A special QSL card will commemorate all contacts and reception reports, and QSL's will be handled exclusively through the *Short Wave Magazine*, at the end of the flight. Readers are asked to report in advance to us—by January 18, February 15 and March 15—any results obtained up to those dates, for mention in the February, March and April issues of the *Magazine*.

## QSL Bureau

Cards are held for the G's listed below, whose addresses are not in our lists. Please send three large stamped self-addressed envelopes, and present or future cards will be forwarded: G2ACA, G2ATZ, G2BMS, G2DPH, G2FLB, G3ASD, G3AUH, G3AUP, GM3AWF, G3BH, G3WN, G5MV, G8TJ.

Address QSL Bureau, *Short Wave Magazine*, 49 Victoria St., London, S.W.1.

## Error Crep' in Dept.

Or, if you prefer it, Corrigenda. December issue, page 604, col. 1, line 5, and Table of Values, page 605, read 0.8  $\mu$ H for the inductance of L2 in G3AAT's article on Grounded Grid Technique. He also wishes to acknowledge Messrs. Standard Telephones & Cables, Ltd., as the source of the excellent photograph on page 537 of the November issue.

Page 613, December; the passage under "Upper Half" should read "... the bottom and top dimensions being nominally 1 ft. 6 in. and 6 in. respectively." G2ANR was not trying to turn the top section of his mast upside down!

## "Pse QSL"

Transmitters who would like reports from SWL's are invited to send us details covering the band(s) and type of transmission on which they are wanted, the distance from which they are required, the QTH for QSL's, and operating periods.

This information will be published in a new *Short Wave Listener* feature under the heading "Pse QSL," on the understanding that SWL reports so received will be acknowledged by card.

## Do You Know That

Losses in an ordinary twisted pair (lighting flex) feeder line can absorb anything up to 40 per cent. of the output from the transmitter—and can seriously affect receiver efficiency? If you employ low impedance feed either way, use a transmission line of the best possible quality. A fairly satisfactory compromise is a feeder made of *untwisted* lighting flex, with the silk insulation stripped off and the two rubber-covered leads held parallel by tying together at intervals.

## VK/ZL Six-Metre Activity

It is now high summer with them, and the ZL's and VK's are looking forward to a great increase in the use of their 50-54 mc band. From NZART's *Break-In* for September it appears that ZL2PD has started well with reception up to 120 miles; VK/ZL contacts are confidently expected this season.

# THE MONTH WITH THE CLUBS

## THE MAGAZINE 1.7 mc CLUB CONTEST

The event of the month—if not the year—was “MCC,” in which 20 of the the 23 original entries took the air and did battle. The 1.7 mc band was stirred out of its normal state by “CQ MCC” echoing late into the night for the whole period, and now everyone is clamouring for more!

The results are the thing, so here they are:

- 1st: Coventry Amateur Radio Society, G2YS.
- 2nd: Cheltenham Amateur Radio Society, G3LP.
- 3rd: Grafton Radio Society (London), G3AFT.

Coventry put up a very fine score of 1245 points, and were hotly contested by the runner-up, Cheltenham, with 1225. This close finish with a difference of only 20 points in over a thousand meant much checking, re-checking and re-counting, but there is no doubt—and the Editor's decision, as usual, is final!

Grafton with 1152 also put up a fine show, as did the others scoring over 1000, who were Salisbury (G5DZ), Grays (G2YH) and West Cornwall (G2JL). Hearty congratulations all round—the full Roll of Honour in tabulated form appears on the next page.

### Zones Worked

It is obvious from the table that “it's the Zones that count.” The winner and the 3rd scorer both hit six zones out of the possible nine. Nearly everyone worked D2CH (Plon, near Kiel) and OZ1H; G2YS worked GC2FMV; G3AFT worked OK1AW, our old friend in Mestec Kralove. The nine zones available altogether—meaning they were all worked by *someone*—were G, GI, GM, GC, GW, OZ, D, OK and EI. Calls Heard lists in this issue show that many more were *heard* by OK1AW and also by G3AWR in Belgium.

### The Leading Stations

The winning station, G2YS, was

operated by J. W. Swinnerton (G2YS), R. Palmer (G5PP) and J. Tuck (G6TD). Hearty congratulations to this winning team, who worked D2CH in broad daylight; otherwise most of their contacts were in the South of England. G2YS worked Break-In, and the members heartily approved the rules, making the one suggestion that an exchange of serial numbers might be preferable next time, to avoid “rubber-stamp QSO's.”

The runner-up, Cheltenham, was a solo effort, and a very fine one, N. O'Brien (G3LP) being the only operator. He also worked D2CH in daylight, but found GW difficult, although only “next door.” Cheltenham's only query is “When is the next one?”

Grafton (G3AFT) would have rated second but for a readjustment of score which was unfortunately necessary. As it is they are a very fine third. They had a team of eight operators—G2AHB, G2BAB, G3AFC, GW3ALE, G3RX, G8DF, G8PL and G8QU. Other club members who could not operate did their stuff with log-keeping, and doubtless in brewing many cups of tea! Grafton does not criticise the rules, but wants to see a “North v. South” contest next time.

### The Rules

Very few entrants criticised them; they appeared to satisfy almost everyone, although one or two suggest that the total duration was too long, and one did not approve of the “multiplier” system. A few who suggested limiting the number of operators to two are referred to G3LP's solo performance in coming second! Note that the highest number of points before multiplying—245—also came from this station.

It is nice to note that practically everyone refers to the very high standard of operation and the use of QBK, QLM, and so on. There were very few complaints of QRM or obstruction. Several clubs had hard luck in one way or another, though. Hull, for instance,

had to contend with an aerial fouling a telephone wire, among other hazards.

Scotland's representative (GM2FZT) was unlucky with the zones, and we imagine that the rules probably did weigh a little heavily against them. On the other hand, West Cornwall (G2JL) managed 5 zones in spite of their great distance from the Continent. So on the whole we are satisfied with the layout.

From *The Short Wave Magazine's* point of view the contest was an unqualified success. Co-operation by the Clubs was splendid, and your Club Secretary is especially pleased to record that most of the logs sent in were a joy to behold, beautifully set out, and giving no trouble at all in checking. There is no doubt about the real enthusiasm of the contestants, and we of the *Magazine* are looking forward to the next one almost as much as the Clubs themselves.

## THE SHORT WAVE MAGAZINE CLUB CONTEST

November 16-24, 1946

ANALYSIS TABLE

Club	Call-Sign	No. of Zones	Total
1. Coventry ..	G2YS	6	1245
2. Cheltenham	G3LP	5	1225
3. Grafton ..	G3AFT	6	1152
4. Salisbury ..	G5DZ	5	1125
5. Grays ..	G2YH	5	1120
6. West Cornwall	G2JL	5	1020
7. Medway ..	G5FN	4	888
8. Beaumanor	G6AK	4	780
9. Romford ..	G2FLK	4	704
10. Oxford ..	G6VD/A	4	656
11. Kingston ..	G6RS	3	633
12. Wanstead ..	G2BCX	4	584
13. Edgware ..	G3ASR/A	4	576
14. Wirral ..	G8BM	5	505
15. "Hi-Q" ..	GM2FZT	3	372
16. Stroud ..	G5WA/P	2	284
17. Southend ..	G5QK	2	196
18. Surrey ..	G2FWA	3	156
19. Hull ..	G3AMW	2	152
20. Bradford ..	G3NN	1	32

And so, back to work ! Here are this month's reports from 31 Clubs, including some more very welcome newcomers. Please note that the closing date for February is January 15 ; address Club Secretary, *The Short Wave Magazine*, 49 Victoria Street, London, S.W.1—and that date, believe us, is *final* ! Lastly, many thanks from the Staff to all Clubs that have sent us Christmas greetings. It is too late to reciprocate but not too late to wish all Clubs and their members a Happy and Successful New Year.

**Thames Valley Amateur Radio Transmitters' Society.**—The Society's future programmes were fully discussed in November, and the December lecture took the form of a talk and demonstration on a home-constructed VFO by G8SM. G16TK was a welcome guest, and gave an interesting talk. Future meetings will be held on the first Wednesday of each month at the Carnarvon Castle Hotel, Hampton Court, but the January meeting is on January 8.

**Midland Amateur Radio Society.**—Sgt. A. Rhodes, Birmingham City Police, lectured on "Frequency Modulation" to 69 members and visitors in November. G5BJ was in the chair, and a welcome was given to G2AVK, ex-VK5RN. Meetings are held at the Imperial Hotel, Birmingham.

**Cannock Chase Radio Society.**—This Club has been recently formed, and has a meeting room at the Black Horse Inn, Mill Street, Cannock. Several meetings and lectures have been arranged, and also a Field Day in the New Year. The December meeting was a "Brains Trust" and future gatherings are to be held on the first Tuesday of the month at 7.30 p.m. The next will be a junk sale.

**Wolverhampton Amateur Radio Society.**—Mr. A. Devey, District Radio Inspector, talked to 47 members on "Interference Suppression" at a recent meeting. The lecture was illustrated by drawings and apparatus loaned by the GPO, and was a great success. It is hoped that meetings in future will be held twice monthly.

**Kingston & District Amateur Radio Society.**—Membership now totals 62, of whom 40 turned up at the November meeting. At this gathering all those present were asked to state their main interests in radio. A VHF portable group was formed, and others will follow. On January 9 there is to be a talk by G2CUA on "Aerial Coupling Systems," and on January 23 a general meeting, both at The Three Fishes, near Kingston S.R. station.

**Surrey Radio Contact Club.**—The December meeting took the form of a Junk Sale, G8DN coming over from North West Kent to serve as auctioneer ! Over 60 were present and much gear changed hands, although some was left over. Next meeting is on January 14.

**Grafton Radio Society.**—"MCC" was the big event, and during the contest G2AHB was nearly removed by lightning during a freak storm ! Morse classes continue, and members of the Practical Section recently brought along some ex-German radar gear, examined with much interest. Meetings continue on every

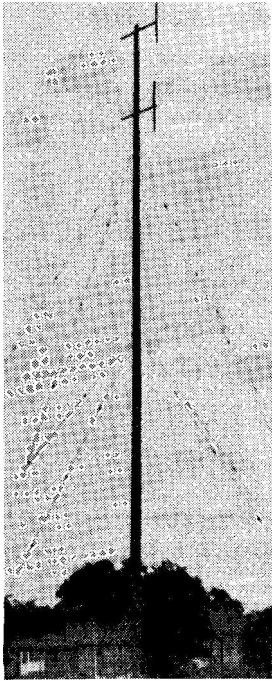

The 90-ft. VHF mast at the Eddystone works.

Monday, Wednesday and Friday, Grafton thereby holding the record for "high-frequency meetings." The Club sends New Year greetings to all other Clubs and their respective members.

**Bradford Short Wave Club.**—Membership is still increasing, and future meetings include an auction on January 6, "An Acoustic Experiment" on January 23, and a lecture on

"Quartz Plates" (illustrated by slides) on January 27. The Club transmitter, operating on 1.7 mc, is an added attraction, and all meetings are now well attended.

**Slade Radio.**—The Club is entering a new season with enthusiasm, and hopes to hold fortnightly meetings. A series of D-F tests has also been organised. The new season's programme will be published shortly.

**Edgware & District Radio Society.**—Entrants for the "constructors' award" recently took their gear along to a meeting, and judging was carried out. G2IM carried off "first" for a multi-range test meter. The MCC kept members busy for a period, and all are shouting for more. The Club now has 90 members and is flourishing nicely.

**Cheadle & District Amateur Radio Society.**—A very successful first Annual General Meeting elected a committee, adopted the rules, and brought the news that the Chairman of the Town Council will formally open the Society early in the New Year. A Club room with plenty of aerial space has been acquired, and everything is really flourishing. With such enthusiasm added to civic blessing the Society should have a really prosperous year!

**Aberdeen Amateur Radio Society.**—The first meeting was held in November with 35 members present, and Mr. A. G. Anderson, B.Sc. (Vice-President) gave a short film show of amateur stations, field days and conventions. Permanent premises have been obtained in the Forsyth Hotel, Aberdeen. For secretary's QTH see panel.

**Oswestry & District Radio Society.**—"Transmission Lines and Aerials" were discussed at the November meeting, with G2NX covering the fundamentals and G6US the practical aspects. Meetings will in future be held fortnightly, and a good programme has been prepared.

**West Cornwall Radio Club.**—The Club made history last month by relaying the results of a Rifle Shooting Match from two amateur stations 15 miles apart, with the full consent of the PMG! G2JL/P was at Penzance and G3AGA/P at Helston. The "broadcast," on 1.7 mc, was followed not only by the contestants but by many local residents. The Club's DX Contest is running now; meetings are held at Penzance on the first Thursday of each month and at Falmouth on the third Thursday, both at 7.30 p.m. Membership is increasing rapidly.

**Maidstone Amateur Radio Society.**—This Club has been reformed, and meetings are held every Wednesday at 244 Upper Fant Road, Maidstone. The future programme includes the construction of the Club's own transmitter and receiver, and many interesting lectures are also "on the cards."

**Swindon & District Short Wave Society.**—The December meeting took the form of a talk on "Sound Recording," by Mr. Allan, of the Air Ministry (late of G-B Films). The President of the Oxford Radio Society was a welcome visitor. Three new call-signs issued in the town bring this Club's total of licensed members up to 17. Meetings are held fortnightly.

## The Editor Wants

- ★ Photographs with Notes for the "Other Man's Station" series.
- ★ Photographs of Equipment of Amateur Radio interest, home and overseas.
- ★ Photographs of Club Meetings.

All material accepted for publication is paid for on appearance. Photographs must be clear and sharp, but can be any size, and either print or negative.



**West Bromwich & District Radio Society.**—The Club now meets every Monday at 7.30 p.m. at the Gough Arms Hotel. A technical library has been started, with an advice bureau. Recent lectures were by G5JU on the "Eddystone 504," and G5KS on "Cathode Ray Oscillographs."

**Wirral Amateur Radio Society.**—At the November meeting 38 members heard an interesting talk by G3CK on "Transmitter Design—the Oscillator Stage." The December meeting took the form of a Quiz, and in January members will give short talks on varied subjects.

**York & District Short Wave Club.**—Fourteen members have been enrolled, and G5KC's Morse classes are going well. New premises are being sought for the future. Three members await the next licence examination.

**North East Amateur Transmitting Society.**—This Club, now reformed, has a membership of 44, of whom 30 are active transmitters. Meetings are held on the last Monday of each month, alternately at North Shields, South Shields and Sunderland. A DX Contest was held on December 7/8—results will be announced at the next meeting. Members have set a fine example to other Clubs all over the country by voluntarily confining 'phone operation to the HF ends of all bands.

**West Middlesex Amateur Radio Club.**—Future programmes are as follows: January 8, G3SU on "Short Wave Receivers"; January 22, Mr. J. Teague on "V.H.F. Oscillators"; February 12, Mr. A. C. Gott on "Principles of Radar"; and February 26, G6CJ on "Aerials," with the famous demonstration. All meetings will be held at the Labour Hall Rooms, Southall, at 7 p.m.

**Beaumanor Amateur Radio Society.**—The club now has its call-sign—G3BMR—with full facilities on all bands. A CC transmitter for 58 mc is under way, and the facilities of an excellent clubroom are being enjoyed, through the kindness of the President, Lt.-Col. Ellingworth, O.B.E.

**Wigan & District Amateur Radio Club.**—Welcome to another newcomer! The Club is now on a firm footing and the future programme is clear-cut, with lectures, discussions and the assembly of a workshop. A junior section has also been formed for the benefit of the younger members, and this section is looking after constructional work.

**R.A.F. Amateur Radio Society.**—The past month has seen much activity at Cranwell, the Tuesday lectures covering "H.F. Aerials," "Centimetre Waves" and "Amateur Radio in Burma." The new G8FC transmitter is also under way

Following are the names and addresses of the secretaries of the clubs mentioned this month. They will be pleased to give every assistance to prospective members.

**ABERDEEN.** A. D. J. Westland, 17 Beaconsfield Place, Aberdeen.  
**BEAUMANOR.** E. Pethers, Beaumanor Park, Loughborough, Leics.  
**BRADFORD.** (Short Wave Club): V. W. Soven, G2BYC, Rushwood, Grange Park Drive, Cottingley, Bingley, Yorks.  
**CHEADLE.** V. E. Hughes, G3AVG, Abbots-Haye, Cheadle, Stoke-on-Trent.  
**CANNOCK CHASE.** K. R. Boot, G2FZG, 75 Beech Tree Lane, Cannock, Staffs.  
**CRAY VALLEY.** G. Miles, G2CXO, Cotswold, Mottingham Lane, London, S.E.9.  
**EDGWARE.** R. H. Newland, G3VW, 3 Albany Court, Montrose Avenue, Edgware.  
**FARNBOROUGH.** P. R. Burkett, G4PS, Park View, Priory Street, Farnborough, Hants.  
**GRAFTON.** W. H. C. Jennings, G2AHB, 82 Craven Park Road, London, N.15.  
**ILFORD.** C. E. Lagen, 44 Trelawney Road, Barkingside, Ilford, Essex. (Tel.: Hainault 126).  
**KINGSTON.** J. J. Hughes, 12 Hillingdon Avenue, Ashford, Middx.  
**MAIDSTONE.** A. H. J. Warner, G3ABZ, 288 Tonbridge Road, Maidstone, Kent.  
**MIDLAND.** W. J. Vincent, G4OI, 342 Warwick Road, Solihull, Birmingham. (Tel.: Solihull 0413).  
**NORTH-EAST.** J. W. Hogarth, G3ACK, 4 Fenwick Avenue, Blyth, Northumberland.  
**NORTH-WEST IRELAND.** D. R. J. Adair, Cosy Lodge, Culmore Road, Londonderry, N.I.  
**OSWESTRY.** G. H. Banner, G3AHX, 6 Coppice Drive, Oswestry, Salop.  
**RAF.**—N. Davis, No. 1 R.S., RAF Cranwell, Lincs.  
**READING.** L. A. Hensford, B.E.M., G2BHS, 30 Boston Avenue, Reading, Berks. (Tel.: Reading 60744).  
**SHEPPEY.** F. G. Maynard, G4OU, 160 Invicta Road, Sheerness, Kent.  
**SLADE.** L. A. Griffiths, 34 Florence Road, Sutton Coldfield, Warks.  
**STOKE-ON-TRENT.** D. Poole, 13 Oldfield Avenue, Norton-le-Moors, Stoke-on-Trent, Staffs.  
**SURREY.** L. C. Blanchard, 122 St. Andrews Road, Coulsdon, Surrey. (Tel.: Uplands 3765).  
**SWINDON.** P. Greenwood, G2BUJ, 49 Western Street, Swindon, Wilts.  
**THAMES VALLEY.** D. R. Spearing, G3JG, Thurston, Orchard Way, Esher, Surrey. (Tel.: Esher 3396).  
**WEST BROMWICH.** R. G. Cousens, G3BCS, 38 Collins Road, Wednesbury, Staffs.  
**WEST CORNWALL.** R. V. Allbright, G2JL, Greenacre Cottage, Lidden, Penzance.  
**WEST MIDDLESEX.** N. Priest, 7 Grange Road, Hayes, Middx.  
**WIGAN.** H. King, 2 Derby Street, Spring View, Wigan.  
**WIRRAL.** B. O'Brien, G2AMV, 26 Coombe Road, Irby, Heswall, Ches.  
**WOLVERHAMPTON.** W. O. Sturme, G8KL, 3 Broome Road, Wolverhampton.  
**YORK.** G. W. Kelley, G5KC, 146 Melrosegate, York.

and DX has been worked with the exciter unit alone. The workshop is proceeding apace, and first-class facilities for constructors will be available. The Debden section of the Society, at the Empire Radio School, is on the air on 1.7 and 3.5 mc with the call-sign G8QD and G2FNX.

**North West Ireland Amateur Radio Society.**—A DX listening contest was held recently; Mr. S. Foster won the 'phone section, and Mr. D. R. J. Adair the CW section. A Club transmitting licence has been applied for, and discussion is rife on the design of the Club gear. A permanent home has been obtained for it and all hands are hard at work!

**Sheppey Amateur Radio Club.**—Slow Morse transmissions are put out every Sunday at 1500 on 1.9 mc by G4OU, G2DCG and G2HKU; theory classes are being arranged; visits to places of interest are in the offing. In short, the Club has thrown off the former depression and is looking forward to a very successful season.

**Cray Valley Radio Transmitting Club.**—This Club held its inaugural meeting at Sidcup

in November, and future meetings are to be held on the third Thursday of each month at the Drill Hall, Lamorbey House, Haldway Street, Sidcup. The chairman is Mr. E. Redpath (G2DS); secretary's name and address in panel.

**R.A.E. & Farnborough District Radio Society.**—Welcome to this new society, which meets in the snack bar at R.A.E. At least ten call-signs are represented, and the next meeting is on January 6 at 7 p.m. All interested parties welcomed—secretary's name in panel.

**Stoke-on-Trent & District Amateur Radio Society.**—The society reports with great regret the death of Col. F. E. Wenger, O.B.E., M.C., T.D., D.L. (G2VG), who held a transmitting licence in 1907 and was still a great enthusiast. Many meetings were held at Col. Wenger's house, and the news of his death will be received with great sorrow by his many friends all over the radio world.

Recent club meetings have been well attended, and the club was invited *en bloc* to the North Staffs branch of the Association of Mining Electrical and Mechanical Engi-

neers to hear a lecture on "Radar" at Hanley. A "Get-Together" dinner and concert is being arranged early in the New Year.

**Ilford & District Amateur Radio Society.**—This well-known Society is flourishing again—and welcome to these pages. Recent lectures have been by Mr. J. Degruchy on "Meters," Mr. H. A. Hartley on "Speakers and Amplifiers," and by members. The transmitter is being rebuilt, and Morse classes are held on Mondays. Normal club meetings are on Thursdays at 8 p.m. On January 16 Mr. G. Parr is talking on "Electro-Biological Recording Amplifiers," and on January 30 Mr. F. H. Haynes on "The 100-watt Transmitter."

**Reading & District Amateur Radio Society.**—A Hamfest was held in December; this, with 60 members present, was a great success. Dr. Lemon (G2GL) gave a talk and demonstration on "RF Heating"; there was a Quiz, and a Junk Sale and Film Display rounded off the day. The vote of thanks to the Committee was proposed by the Editor, who was a guest on this occasion.

## WELL, WELL

I had just been reading your Funny Five Minutes when to my astonishment the 'phone bell rang, and there was G9BF on the wire. In a suspiciously charming and innocently-flavoured voice he asked me, quite casually, "Have you got any 5-metre crystals, OM?"

Needless to say, I was brought up abaft with my mainsails shivering and agibe, as a mariner *might* say. I gave his question some hard thought and then taking the bull by both horns and the tail, replied in what I hoped was an equally charming and innocently-flavoured voice with the simple monosyllable "Yes."

I got the impression that G9BF was vaguely perturbed. Perhaps he was wondering which of us was sane. By this time the telephone handset was charged with RF; perhaps this was what made G9BF reply, rather hurriedly, "Well, if you would kindly test them for me, I will

buy some from you." And with that he rang off without even a goodnight.

You can take it from me, fellas, that guy G9BF is not so BF as they say he is!  
(73, G3VU)

## SCHOOL-ROOM DX

The idea of increasing interest in both science and geography by running an amateur station in class may seem a little spectacular to some, but H. W. Simpson, B.Sc. (G8DI) has put this scheme into practice. He is science master at Rose Lane Secondary School, Mossley Hill, Liverpool, the school call being G8LL.

G8DI and a friend built the transmitter and behind it, on the class-room wall, is a large coloured map with strings leading from the locations of stations worked to their QSL cards, which surround the map.

Mr. Simpson would be very interested to get into touch with other teachers holding amateur transmitting licences, and to supply any further information regarding his own particular venture.

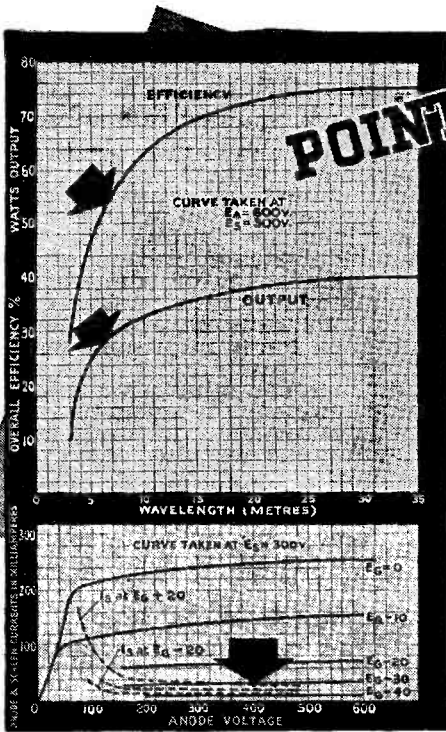

**POINTERS FOR DESIGNERS**



**T H E K T 8**

The OSRAM KT8 is a transmitting beam tetrode particularly suitable for use as an R.F. amplifier, oscillator or frequency multiplier. Its outstanding features include:—

- A useful output down to wavelengths of the order of six metres.
- “Aligned grids” resulting in low screen current, largely removing the limit usually set by screen dissipation.
- Low interelectrode capacities normally making neutralising unnecessary.

A detailed technical data sheet is available upon request

**Osram**  
PHOTO CELLS

**S.E.C.**  
CATHODE RAY TUBES

**Osram**  
VALVES

**VALLANCE'S INTRODUCE—**

to Newcomers to the Ham Bands **The W.F.25D C.W. Transmitter.** Efficient, dependable, and ready for immediate C.W. operation. Can be supplied with modulator for 'phone operation.

**SPECIFICATION**

Power Input—25 watts C.W.

Fq. range—Plug-in coils for 10 to 160 meter bands. Complete with link output.

Valves—Metal 6L6 xtal controlled oscillator feeding 807. 5U4G Power Supply.

Metering—Grid and Anode of 807. Separate meters.

Controls—Mains switch with pilot lamps. Stand-by Transmit Switch with indicator lamps. P.A. Tuning Control. Osc. Tuning Control. Jacks for keying in C.O. or 807.

The equipment is complete in beautifully finished grey cellulose case with chromium carrying handles. All components and insulation are of the highest quality, and each instrument is fully tested on the air before delivery. The WF25D is the first of a series of units now in course of production. An outstanding feature of its design is that not only is it a most efficient C.W. Transmitter, but it may ultimately be used as a Driver Unit for the WF150F, 150 watt Power Amplifier, without any alteration. It can, therefore, form the first unit of a high power transmitting outfit, thereby considerably cutting down cost when High Power is required. From stock. £39/10/-

**The WF150F POWER AMPLIFIER,** complete in finished grey cellulose double shelf case, with chrome carrying handles. Consists of power supply and P.A. on separate chassis. In conjunction with the WF25D an efficient 150 watt C.W. Transmitter of excellent quality, and pleasing appearance, can be used on the major bands. The P.A. unit is easily disconnected enabling the WF25D to be worked on bands where lower power is necessary. Delivery 6-8 weeks from receipt of order. Price on application.

**50 watt MODULATOR.** This will be available shortly, and will give sufficient audio output to plate and screen modulate the 813 tube in the P.A. 100 per cent. *Specification:* 6C5 pre-amplifier, 6C5 driver, 807 in class A B push-pull. Complete in grey cellulose case with chromium carrying handles. Detailed specification and price available shortly.

A smaller version of the modulator will be produced at some later date, suitable for use with the WF25D.

*Specialists in Radio Components and Equipment of Guaranteed Quality.*

**VALLANCE'S, 144 Briggate, Leeds, 1.**

**THE  
PARTRIDGE  
ORGANIZATION**  
is again at your service.

For six years we have been supplying the Services with our iron cored components. We are now once more accepting orders for ordinary commercial and domestic needs.

Our technical department will again be pleased to assist you in your transformer problems.

We look forward to hearing from our old friends, and welcome enquiries from newcomers.

May we send you our 1946 price list? This details a comprehensive range of components that can now be despatched from stock.

Telephone:

Abbey 2244

**PARTRIDGE**  
**TRANSFORMERS LTD**  
76-B. PETTY FRANCE, LONDON, S.W.1

**Varley**  
REGD. TRADE MARK

*Products of  
Quality & Reliability*

**MAINS TRANSFORMERS  
A. F. TRANSFORMERS  
SMOOTHING CHOKES  
THERMAL  
DELAY SWITCHES  
POWER RESISTANCES**

*Made by*

**OLIVER DELL CONTROL LTD**

Telephone. WOOLWICH 1422  
CAMBRIDGE ROW · WOOLWICH S·E·18

# Study television at its source!★



**E.M.I. Research and Development** Laboratories were largely responsible for the Marconi-E.M.I. system of television transmission used by the B.B.C. Service—the first in the world.

**E.M.I. Factories** produce the finest television receivers in the world.

**E.M.I. Service** department is the largest and most expertly equipped in the country.

★  
read about  
this new  
opportunity

**NOW—E.M.I.** have set up a TRAINING ORGANISATION to provide immediate courses on practical TELEVISION (Postal and College Courses.)

**SOON** this new Training College will extend its syllabus to cover all branches of Electronic Science.

**This is your** opportunity to secure a thorough training in Television from the very pioneers of the Science.

Ask your local H.M.V. dealer for further details or send for our free pamphlet which gives full details of this and other courses.

## E.M.I. INSTITUTES, LTD.

Dept. S.W. 3, 43 GROVE PARK RD., CHISWICK, LONDON, W4

*Associated Company of:* THE GRAMOPHONE CO. LTD. ("HIS MASTER'S VOICE")  
THE MARCONIPHONE CO. LTD., MARCONI-E.M.I. TELEVISION CO. LTD., RADIOMOBILE LTD., ETC. ETC.

ALIGNED INSTRUMENTS SERVICES \* 30 COIL PACK SERIES

ALIGNED INSTRUMENTS SERVICES

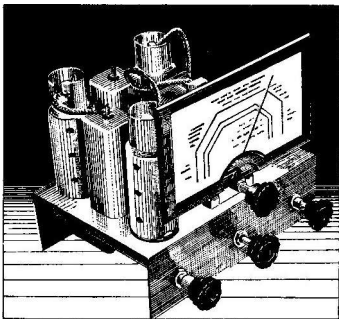

### 30 COIL PACK SERIES

The now famous 30 Coil Pack is accepted as the finest unit of its kind. It is available in 8 models to suit every type of circuit. Send 1d. stamp for complete Information Bulletin "M" and Price List.

### A.I.S. TUNING HEART MODEL 30. (As Illustrated)

This latest All-wave Superhet unit incorporates the 30 Coil Pack and can be coupled to any amplifier. Employs 6K8G-6K7G- and 6Q7G valves, and covers all stages from Aerial to 1st A.F. amplifier. Wavebands: 16-50, 200-550-750-2,000 metres. Requires 250v at 20 m.a., and 6.3v at 0.9 amps. Price £8 10 0

Send 1d. Stamp for Price List 'M'

### ALIGNED INSTRUMENTS SERVICES

1 COLWORTH ROAD, LEYTONSTONE, E.11

ALIGNED INSTRUMENTS SERVICES

ALIGNED INSTRUMENTS SERVICES \* 30 COIL PACK SERIES

## H.A.C.

### Short-Wave Equipment

Noted for over 15 years for  
Short-Wave Receivers and Kits of quality

One Valve Kit, Model "C" Price 20/-  
Two " " " " "E" " 43/-

These kits are complete with all components, accessories, and full instructions. The prices are inclusive of postage and packing. Send stamped addressed envelope for descriptive catalogue

A. L. BACCHUS, 109 Hartington Road,  
London, S.W.8

## LONDEX for RELAYS

### AERIAL CHANGE-OVER RELAY

for Radio Frequency  
Type A.E.C.O.4.

3 V.A. Coil Consumption, especially designed for Transmitters. High Frequency Heating, Amateur Stations, etc. Ask for leaflet 112/SW.

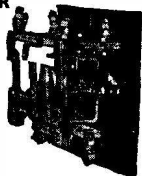

## LONDEX LTD

MANUFACTURERS OF RELAYS

207 - ANERLEY ROAD - LONDON - S.E.20

SYDNEY  
6258-9

EX-GOVERNMENT

## WONDERFUL RADIO BARGAINS

### 1 1/2 METRE 10 VALVE SUPERHET UNITS

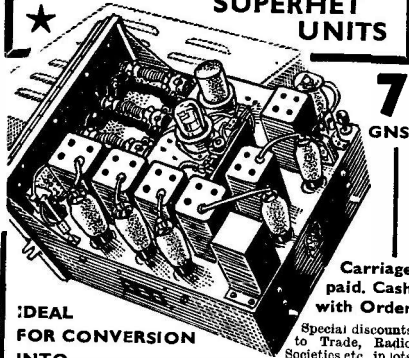

7  
GNS

Carriage  
paid. Cash  
with Order

IDEAL  
FOR CONVERSION  
INTO -

Special discounts  
to Trade, Radio  
Societies etc., in lots  
25 or more receivers.

### TELEVISION RECEIVERS!

Circuit Comprises.—1 Pre. Amp. Osc. Mixer. I.F. Det. Video Amp. I.F. Frequency 12 Megs. Bandwidth 4 Mega. Co-axial input and output sockets. External source of L.T. and H.T. supply is required. Manufactured to stringent Government specification by such famous makers as R.G.D., Pye and Murphy. Brand new and unused and in manufacturers' sealed cartons. Complete with 10 Mazda valves.

WIRELESS INSTRUMENTS (LEEDS) LTD.  
54 & 56 The Headrow, Leeds, 1. Tel. 22262

G 80 G

## BERT DOBSON 6 GRAND ARCADE, LEEDS, 1

Tel. : 22175

We sell only brand new radio components and buy only from legitimate wholesalers and manufacturers. No ex-dump stuff here. Nothing second-hand.

The following have just arrived—T.C.C. Mica Condensers, .002 MFD 2000 volt working, 5000 volt test. Price (list), 7/- (per post 7/3).

Celestion Amphenol Ceramic Valve Holders, American 4-pin, and American 5-pin and International Octal. Price (list), 3/6 (per post 3/9).

Woden UM2 60 watt modulation transformers. Price 51/- (per post 52/-).

Jack Plugs, 2/6, or 2/9 per post.

Jacks, open and closed circuit, 2/6 or 2/9 per post.

Toggle Switches, SPST, 3/9 post free.

Toggle Switches, DPST, 4/3 post free.

Eddystone Adjustable Brackets, price 2/6 post free.

Eddystone RF Choke (Transmitting Type, 250 mils). Price 3/- (per post 3/3)

G 80 G

New Stocks

Just Arrived

Right Up-to-Date  
RADIO VALVES OF THE WORLD  
An International Reference Handbook  
from Obsolete to Modern types

International

### "RADIO VALVE VADE-MECUM"

P. H. Brans

12s. 6d.

Section I Continental and American valve characteristics.

II British valve characteristics.

III Comparison and equivalent tables.

IV Replacement valves.

V Base connection diagrams of 689 valves.

VI Russian valve characteristics.

VII Inter-services (Allied) valve tables.

VIII German and Italian army valve characteristics.

FREE QUARTERLY SUPPLEMENT SERVICE

Obtainable from Publishers' Representatives

THE MODERN BOOK COMPANY  
(Dept. V)

19-21 Praed Street, London, W.2. Pad. 4185

or

RITCHIE VINCENT & TELFORD LTD.  
(Dept. V)

136A, Kenton Road, Harrow, Middlesex.

Wor. 3970



# The CRITERION amongst GOOD TRANSFORMERS

The prices shown below are the current list prices and include the increase effective from November 1, 1946. Please send for complete revised Price List.

## MULTIMATCH MODULATION TRANSFORMERS

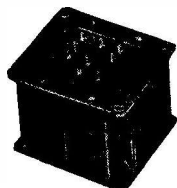

Woden engineers have developed a special range of Multimatch modulation transformers for Amateur Transmitting use, details of which are given below. The transformers are vacuum impregnated and fitted in compound-filled steel pots giving reliable and silent working.

Primary impedances, 2,000/18,000 ohms. Secondary impedances, 200/20,000 ohms.

- TYPE U.M.1. Suitable for 30 watts Audio. Max. Sec. current, 120 m/a 38/5
  - TYPE U.M.2. Suitable for 60 watts Audio. Max. Sec. current, 200 m/a 51/-
  - TYPE U.M.3. Suitable for 125 watts Audio. Max. Sec. current, 250 m/a 73/2
- Larger sizes to order.

## DE LUXE TYPE TRANSFORMERS AND CHOKES

This entirely new range of transformers and chokes housed in streamlined die-cast cases enable equipment to be constructed setting a standard not hitherto attained. Full details are given in our lists and a representative range is given below.

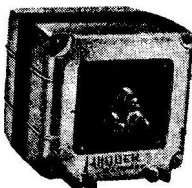

### MAINS TRANSFORMERS

- |                                   |   |
|-----------------------------------|---|
| D.T.M.11. 250-0-250 60 m/a 32/5   | D.T.M.16. 650-0-650 200 m/a 67/9              |
| D.T.M.12. 275-0-275 120 m/a 46/10 | D.T.M.17. 750-0-750 250 m/a 98/5              |
| D.T.M.13. 350-0-350 120 m/a 50/5  | D.T.M.18. 1250-1000-0-1000-1250 300 m/a 150/- |
| D.T.M.14. 425-0-425 150 m/a 58/6  | D.T.M.19. 1500-0-1500 350 m/a 169/2           |
| D.T.M.15. 500-0-500 150 m/a 58/6  | D.T.M.20. 2000-0-2000 350 m/a 192/-           |

### FILAMENT TRANSFORMERS

- |                                     |                                   |
|-------------------------------------|-----------------------------------|
| D.T.F.11. 2.5 v. 5 amp. C.T. 27/-   | D.T.F.17. 7.5 v. 5 amp. C.T. 30/8 |
| D.T.F.12. 2.5 v. 10 amp. C.T. 34/10 | D.T.F.18. 5 v. 3 amp. C.T. 31/9   |
| D.T.F.13. 4 v. 10 amp. C.T. 36/7    | D.T.F.19. 6.3 v. 4 amp. C.T. 31/9 |
| D.T.F.14. 5 v. 4 amp. C.T. 27/-     | D.T.F.20. 4 v. 2.5 amp. C.T. 31/9 |
| D.T.F.15. 6.3 v. 4 amp. C.T. 27/-   | 4 v. 6 amp. C.T. 51/7             |
| D.T.F.16. 4 v. 6 amp. C.T. 27/-     |                                   |

### SMOOTHING CHOKES

- |  |
|--|
| D.C.S. 11. 12 Hy 60 m/a. D.C. Resist. 550 ohms 17/10                           |
| D.C.S. 12. 12 Hy 150 m/a. D.C. Resist. 190 ohms 25/-                           |
| D.C.S. 13. 12 Hy 250 m/a. D.C. Resist. 180 ohms 51/7                           |
| D.C.S. 14. 12 Hy 350 m/a. D.C. Resist. 60 ohms 94/10                           |
| D.C.S. 15. 12 Hy 500 m/a. D.C. Resist. 80 ohms 103/2                           |
| D.C.S. 16. 12 or 60 Hy 100 or 50 m/a. D.C. Resist. 250 ohms or 1,100 ohms 25/- |

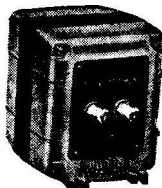

## NEW DUAL TESTOSCOPE



Ideal for  
High and Low  
Voltage Testing; 1/30  
100/850 A.C. and D.C. Allowance made  
on old models. Send for interesting leaflet  
L34 on Electrical and Radio Testing,  
from all Dealers or direct.

## RUNBAKEN MANCHESTER-I

### A MINE OF INFORMATION

Everything you need in Radio and Electronics is shown in our 111-page catalogue—packed with interesting items by well-known manufacturers, including a complete valve range. No job clearance lines whatsoever.

A shilling postal order will bring you this catalogue post free.

SEND TO-DAY

**B : T : S**

63 London Road, Brighton 1, Sussex

Tel. : Brighton 1555.

## ODEON RADIO

(Registered "Eddystone" Dealers)

**Receivers**—available for immediate delivery—the new "Eddystone" 504 communications receiver, £58/18/6.

**Transmitting Valves.** American 807, new and guaranteed, 17/6.

**Test Gear.** Taylor 45A portable Valve Tester, £20. Avometer Model 40, £17/10/-. Labgear Crystal Calibrator, 100/1,000 kcs., £13/1/6. D.C. Avominor, £4, 15/-.

**Eddystone Short Wave Manual**, 2/8 post free. Our business is almost exclusively concerned with the supply of high grade components and complete equipment for the transmitting amateur, short wave listener and experimenter, and our "resident ham" G4HV is always available for technical advice and information.

We carry a full range of Eddystone components as illustrated in their 1946 catalogue. Raymart and Denco products are also available from stock.

A prompt and efficient service for the repair and realignment of communications receivers is available.

We have a good selection of technical radio books—too numerous to mention individually—send s/a envelope for list.

All postal enquiries receive careful attention, and goods in stock are despatched by return post.

Shop hours, 9.0 a.m. to 6.0 p.m., including Saturdays. Closed Wednesdays, 1.0 p.m.

**56 COLLEGE ROAD, HARROW.**

2 minutes from Harrow Met. Station

## EX AIR MINISTRY Components



Thermo coupled RF am-  
meters, '5m.a. 2" dial, by 15/-  
leading maker.



Moving coil meter, 30m.a.  
scale; movement 5m.a. shunt-  
ed, 2" dial, by leading makers. 15/-



3-gang condenser, 50 mmfd  
per section extension shaft  
and knob. 7/6



Relay D.P.C.O. with activ-  
ating coil. 2/6

Post Orders add 9d.

Write for list of other bargains.

**THE STAMFORD RADIO CO.**

199 STAMFORD STREET,  
ASHTON-UNDER-LYNE, LANCs.

Telephone : ASHTon 1964.

## LYONS RADIO

3 GOLDHAWK ROAD

SHEPHERDS BUSH, LONDON, W.12

Telephone : Shepherds Bush 1729

### SUPERHET COIL PACK

R.F. and Osc. coils with switch and short wave  
aerial coupling condensers mounted on plate, fully  
wired and tested. Circuit diagram included.  
Designed for I.F. of 465 kc/s.

Wave bands :—1—13—30 metres.  
2—30—60 metres.  
3—200—550 metres.

Price 18/6 (Postage 9d.)

### HEADPHONES

Super quality brand new American lightweight  
midget headphones. Engineered for maximum  
efficiency employing Alnico magnets with soft  
rubber earcups.

A midget matching transformer is fitted for high  
impedance outputs. Flexible rubber cord with  
standard phone plug and spare pair of inserts are  
included.

For both comfort and efficiency they are vastly  
superior to the more usual types of headsets.  
Price complete 27/6 (Postage 1/- extra).

### QUARTZ CRYSTALS

Twin 100/1000 kc/s. Ex. Govt. Plug in type, new  
and unused. Tested by us before despatch.  
Price £1 12/6 each (Post free).

We can supply suitable bases if required at 1/6 each  
(Post free if ordered with crystal)

Our new bargain list will be sent on request.



## RADIOVISION EXPANDER

Extends the range of any receiver to cover :—

Model A 27-30 and 56-60 Mcs.

Model B 14-14.5 and 27-30 Mcs.

Both models are complete with built-in power pack.

## THE V55R

Communications Receiver cover the 14, 7 and 3.5 Mcs. amateur bands. Short, Medium and Long-wave broadcast.

Illustrated Brochure from

### RADIOVISION (LEICESTER) LTD.

58-60 RUTLAND STREET, LEICESTER.

Phone : Leicester 20167.

## U.E.I. CORP.

**WAVEMETERS.** Ex-Government Class D No. 1 Mk. II. Ranges 1900-4000 Kcs., 4000-8000 Kcs., with check frequencies up to 25 Mcs. Employs twin crystal 100/1000 Kcs., and ensures  $\pm$  2 per cent. accuracy. Brand new and unused and supplied with spare valve and vibrator in teak carrying case. Only £6/15/-, or a FEW ONLY WITHOUT SPARES AT 85/- (C.W.O.). Send for leaflet.

**EX. R.A.F.** "Identification Friend or Foe" Receiving and Transmitting units. Complete with valves and rotary transformer. Component value well over £20. Only 75/- (carriage 4/-).

**TRANSRECEIVERS TYPE 58 Mk. I\***, complete with 8 valves, 2 sets of headphones and microphones, telescopic and rod aeriels. Battle Battery, etc., complete and ready to switch on, £10/10/- (carriage 5/-).

**MINIATURE VALVES**, types 1S5, 1T4, 1R5, 3D6/1299, 17/6 each.

**TELESCOPIC AERIALS**, 102" long, collapsing to 15 1/2", 15/-, 16-section rod aeriels, 12/6.

**VIBRATOR UNITS**, 2 v. input, 180 volts at 35 milliamps output, L.T. and G.B. Complete with 2 accumulators. Brand New, £4.

**MAINS TRANSFORMERS.** The "Two-in-One" 350-0-350, 80 ma., 6.3 v. 3 amps, 5 v. 2 1/2 amps, 4 v. 4 amps, 4 v. 2 1/2 amps, 32/6 ; 350-0-350, 150 ma., 6.3 v. 5 amps, 5 v. 2 1/2 amps, 37/6 ; 500-0-500, 200 ma., 6.3 v. 4 amps, 6.3 v. 2 1/2 amps, 5 v. 3 amps, 45/-.

Post orders only. C.W.O. or C.O.D. over £1. Carriage paid over £1. Send S.A.E. for current lists. Country dealers send for particulars of our "Country Dealers Service."

### U.E.I. CORP.

32 St. Gabriel's Rd., London, N.W.2.

# PREMIER RADIO

MORRIS AND CO. (RADIO) LTD.

**ALL POST ORDERS TO : JUBILEE WORKS, 167 LOWER CLAPTON RD., LONDON, E.S. (Amherst 4723)**

**CALLERS TO : 169 FLEET ST., E.C.4 (Central 2833).**

**OUR 1946 LIST IS NOW AVAILABLE.** All enquiries must be accompanied by a 2 1/2d. stamp.

**COLLARO PORTABLE RECORD PLAYERS.** Consist of a high grade electric gramophone motor, 200/250v. A/C, complete with speed regulator, 12in. turntable, automatic start and stop, and super quality magnetic pick-up with reversible head. Contained in a leatherette-covered carrying case. Operates with lid closed. Price £11/5/0.

**FIRST GRADE OIL FILLED PAPER CONDENSERS,** with miniature stand-off insulators and fixing clips, 2 mfd., 1,000 v.w., 2/6 or 20/- per dozen; 2 mfd. 600 v.w., 1/3 each or 10/- per dozen; 1 mfd. 600 v.w., 1/- each, 8/- per dozen. Super Quality Oil Filled Tubulars. Insulation as good as Mica. 1 mfd. 500 v.w., .02 mfd. 750 v.w., 5 mfd., 350 v.w. Either type, 9d. each or 7/6 per dozen.

**P.M. SPEAKERS.** 5in. 21/6, 6 1/2in. 22/6, 8in. 24/-, 9in. 6-watt, 15 ohms 38/-; 12in. 15 ohms 15 watts, a high fidelity job, £6 15/-.

**OUTPUT TRANSFORMERS.** A super production. By means of ingenious series-parallel arrangement, all windings are used at all times. Match and tube, single or push-pull to any voice coil 2-30 ohms. 7 watts, 22/6; 15 watts, 30/-; 30 watts, 49/6; 60 watts, 59/6.

**.0005 CONDENSERS.**—Ceramic insulation, "Bar" type. Single gang, 5/-; twin gang, 8/6; three gang, 10/-; four gang, 10/-.

**KIT OF PARTS FOR H.T. ELIMINATOR AND TRICKLE CHARGER.**—Output 150 v. 30 ma., 2 v. half-amp. Metal Rectification. Amazing value at 30/-.

**B.P.L. SIGNAL GENERATOR,** 100 Kc/s to 30 mc/s in six bands, 1 per cent. calibration, 1 volt into 10 ohms. 30 per cent. modulation by 400 cycle osc., mains driven, £21.

**B.P.L. UNIVERSAL TEST METERS.**—Army type in shockproof bakelite case, 10, 100, 500 volts, A.C. and D.C., at 1,000 op. v. 10, 100, 500 ma. D.C. 0-10,000 ohms, with self-contained battery, £8 15/-; Current Transformer for same, 1, 1 and 10 a. A.C., 39/6.

**MIDGET RADIO KITS.**—Complete with drilled chassis, valves and loudspeaker, only cabinet required, medium and long wave T.R.F. Size 10 in. x 6 in. x 6 in., 4 valves, inc. rect., tone control, A.C./D.C. operation, 200/250v. Circuit and constructional details supplied. Price, including tax, £6 17s. 6d. Cabinet, if required, 25/- extra.

**ROTARY TRANSFORMERS,** input 12 v., output 180 v., 30m/a. 4v. 2-3 a. with 19 volts input, output is 50 per cent. higher. May be used on D.C. mains as L.T. Charger. With small conversion could operate as D.C. Motor. Original cost over £50. Employ powerful ring magnet. Price 10/- each.

**ALUMINIUM CHASSIS.**—Substantially made of bright aluminium, with four sides, 10 in. x 8 in. x 2 1/2 in., 7/-; 12 in. x 9 in. x 2 1/2 in., 9/-; 16 in. x 8 in. x 2 1/2 in., 8/6; 20 in. x 8 in. x 2 1/2 in., 10/6; 22 in. x 10 in. x 2 1/2 in., 13/6.

**I.F. TRANSFORMERS.**—Iron core, litz wound, with or without flying lead, 460/465 k/c., 7/6 each. Miniature type, 1 in. x 1 in. x 2 in., 9/9.

## CLASSIFIED SMALL ADVERTISEMENTS

## TRADE ADVERTISEMENTS

9d. per word, minimum charge 12/-. No series discounts; all charges payable with order. Insertions of Radio interest only accepted. Add 25% for Bold Face (Heavy Type).

**RUBBER STAMPS. FOR HAM USE MADE BY HAM TO YOUR REQUIREMENTS, CALL SIGNS, BRS SIGNATURE STAMPS A SPECIALITY. SPECIMEN IMPRESSIONS SENT FREE UPON REQUEST.—G2FSR, 2 PARKHILL ROAD, CHINGFORD, E.4.**

**SUPER-HET HRO receiver, complete with power pack and five coil units covering all Ham bands and broadcast, Worth £100, first £65 secures.—Mortimer, Dore, Sheffield. 'Phone 70210.**

**ALUMINIUM chassis and panels from 3/9. Any size plain or punched for valveholders, etc. Prompt delivery.—EAD, 13 Bence Lane, Darton, Barnsley.**

**G6VS FOR ALL HAM GEAR—EDDYSTONE 504 RECEIVERS, £58 18s. 6d., INC. TAX; 9-TUBE COMMUNICATIONS RECEIVER WITH FILTER, £30; EDDYSTONE; LAB-GEAR AND "Q-MAX" EQUIPMENT (INCLUDING CHASSIS CUTTERS); CALIBRATED ABSORPTION WAVEMETERS; PULLIN METERS; THOUSANDS OF VALVES; OUR WAVEMETER CALIBRATION DEPARTMENT IS AT YOUR SERVICE—G6VS AND G5DP ALWAYS IN ATTENDANCE.—G6VS (EX-VU2EU), CARLTON MUSIC SALON, WEST KIRBY, CHESHIRE.**

**ODEON RADIO, HARROW. All components, complete equipment, test gear and technical books for transmitting amateurs, short wave listeners and experiments now obtainable from 56 COLLEGE RD., ROXBOROUGH BRIDGE, HARROW (2 minutes Harrow Met.). Prompt repair and re-alignment of communication receivers PERSONALLY SUPERVISED by G4HV. Postal enquiries receive immediate attention. Open 9 to 6.30 daily, including Saturdays. ODEON RADIO, HARROW.**

**QSL CARDS AND LOG BOOKS, APPROVED G.P.O. SAMPLES FREE. ATKINSON BROS., PRINTERS, ELLAND, YORKS.**

**MACCLESFIELD and District. Johnson's (G3AFH) for Eddystone Components, and all Ham gear. Hand picked Govt. Surplus lines, Magazines, etc. Agents for Leading Manfrs. Showrooms at 98 Mill Street, Macclesfield (Tel. : 4080). Service Dept. : Bollington. (Tel. : 2272).**

**WE HAVE THE LARGEST STOCK OF ENGLISH AND AMERICAN RADIO BOOKS IN THE COUNTRY, INCLUDING MANY NOW OUT OF PRINT. Write or call for List, Modern Book Co., 19/23 Praed Street (Dept. V), London, W.2. Pad. 4185.**

## READERS' ADVERTISEMENTS

3d. per word, min. charge 5/-. payable with order.

**HALLICRAFTER SKY-CHIEF, MODIFIED BY G2UQ, PERF. COND. WITH 3 NEW VALVES, OFFERS AROUND £25. ALSO HAM BUILT I-V-I IN MET. CAB. BY G4BI, 4 COILS AND VALVES, REALLY FB BATT. Rx. £10 OR NEAR. CARR. PAID.—Box No. 110.**

**HALLICRAFTER Communications Rx Nine** Valves. Crystal gate. Electrical Bands spread, etc., 7 to 500 Meters. Offers over £25. GEC Oscillograph CRT, 25/-. 7 in. CRT, focus and deflection coils, £5. RK39 15/-. PT15 10/-.—Morris, 34 Birch Avenue, Romley, Cheshire.

**HRO Senior, 5 Coils 1-30 mc and Power Unit, £55. Wanted Valves 2E25,829.—Herrington, 20b Cheriton High Street, Folkestone.**

**SX-28. 540 kc. 43 mc. 6 bands, S-Meter, Noise-Limiter, PP/6V6, V. Selectivity, Hallicrafter Speaker, 15 valves. Offers. 20 CLIFTON AVENUE, LONDON, E.17.**

**SALE. Hallicrafter's Sky Champion. Good Scondition; realigned. First £18 10s. D10A crystal hand-microphone with handle switch. Cost £6 10s. Perfect, £5 10s.—S. G. Abbott, 3 Dundonald Road, Ramsgate, Kent.**

**SALE. National 1-10 complete with Power Pack. Perfect £20. WANTED. Good American Tx, similar HT9 or Collins or other good make.—G2BXL, 33 Prince's Way, Fleetwood.**

**FOR SALE: "OST" FOR YEARS 1933 to 1938, complete with genuine "OST" binders; RADIO GLOBE OF WORLD (Webbs) as new. Offers to Kayak, 89 Primrose Avenue, Chadwell Heath, Essex.**

**CABINETS—heavy grey sprayed steel, Panels 9 in. by 7 in., hinged lids, 23/-.—15 Belgrave Close, Chelmsford.**

**RF THERMO-AMMETERS, 2½ in. SQUARE, REFUSH, UNUSED, EX-AIR MINISTRY, CALIBRATED 0-3 AMPS (MOVEMENT 2mA F.S.D.), WESTON, ETC., 2½" EACH P.F. FOOT MOTOR, NEW UNUSED, £2 C.F., OR OFFERS. WANTED COMMERCIAL RECEIVER (LESS CABINET), SMALL BENCH DRILL, METRIC MICROMETER.—G. METCALF, 59 BARTLETT ST., DARLINGTON.**

**SX25, 12 VALVES, XTAL. S-METER, SB-SPREAD, 43 mc-550 METRES, 6 TYPES SELECTIVITY, JACK PHONE, BFO PITCH CONTROL, ANL, SEND-RECEIVE SWITCH, TONE SWITCH, AS NEW, £2 10s. ON LIVING UP AND OVERHAUL, ALL AS NEW VFB., £55 OR NEAR.—Box No. 109.**

**HRO Senior—Super Sensitive Receiver, complete with coils and power pack—a real DX'er in first-class condition. First £65 secures.—Mortimer, Dore, Sheffield. 'Phone 70210.**

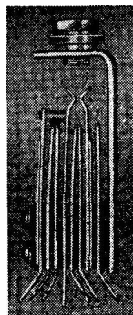

## Multi-contact JACKS

for telephone, metering, and a hundred other uses. To take "Igranic" or any other standard Telephone Plugs. Made in U.S.A. Limited quantity at only 15/- per dozen, plus 1/- packing and postage.

## WIRELESS SUPPLIES UNLIMITED

264-266 Old Christchurch Rd., Bournemouth, Hants.

# CELESTION

## P.M. LOUDSPEAKERS

Chassis Diameter	MODEL	Speech Coil Impedance Ohms	Pole Diameter	Flux Density Gauss	Total Flux	Power Handling Capacity
2½"	<b>P2V</b>	3.0	$\frac{7}{16}$ "	8,500	8,000	.25W
3½"	<b>P3C</b>	3.0	$\frac{3}{4}$ "	7,700	24,000	1 W
5"	<b>P5Q</b>	3.0	$\frac{3}{4}$ "	8,500	26,000	3 W
5"	<b>P5T</b>	3.0	$\frac{3}{4}$ "	10,500	32,000	3 W
6½"	<b>P6Q</b>	3.0	$\frac{3}{4}$ "	8,500	26,000	4 W
6½"	<b>P6T</b>	3.0	$\frac{3}{4}$ "	10,500	32,000	4 W
8"	<b>P8D</b>	2.3	1"	6,200	24,000	5 W
8"	<b>P8M</b>	2.3	1"	8,000	31,000	5 W
8"	<b>P8G</b>	2.3	1"	10,000	39,000	6 W
10"	<b>P10M</b>	2.3	1"	8,000	31,000	6 W
10"	<b>P10G</b>	2.3	1"	10,000	39,000	8 W
12"	<b>P64</b>	12.0	1¾"	12,500	140,000	15 W
18"	<b>P84</b>	10.0	2½"	13,500	350,000	40 W

**Energised Speakers** will be available as soon as restrictions on supplies of wire are removed.

**Output Transformers** for Celestion Loudspeakers can be wound to meet customers' requirements.

PLEASE PURCHASE THROUGH YOUR LOCAL DEALER

**CELESTION, LTD.,**  
**KINGSTON-UPON-THAMES, SURREY**

Telephone: KINGston 5656-7-8

# THE "Q-MAX" COMBINED ABSORPTION WAVEMETER AND PHONE MONITOR

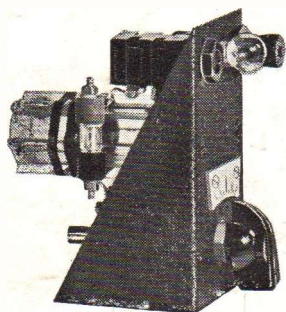

## "Q-MAX" -RTS PRECISION TRANSFORMER

Precision built with a guaranteed tolerance of 2 per cent. vacuum impregnation; cast frames; engraved Tufnol tag panels.

### ETW 8912.

Universal modulation, 100 watt audio to modulate 200 watt R.F. ... .. **6 Gns.**

### ATW 1295. 0-1000-1500-2000v

5MA. 4v 1-5A, 2v 1-5A, 4v 2A ... .. **69/6**

### ATQ 9007. 1750-1500-1250-

0-1250 - 1500 - 1750v  
200 MA. 0-2 5v 5A,  
0-2 4v 4A ... .. **6 Gns.**

### SMOOTHING CHOKE.

Cat. W0891. 180 ohms  
D.C., 20H, 250 MA ... .. **63-**

An Absorption Wavemeter for checking harmonics, parasitics, oscillators, doublers, and power amplifiers for correct frequencies.

All Amateur bands covered by means of plug-in inductances.

A Westector rectifier is incorporated with the wavemeter and also a jack, for phones, thus enabling the wavemeter to be used as a phone monitor.

Supplied with one inductance. **35-**

## AND —

### SUPER SLOW MOTION DIAL For Individual Calibration

50-1 (Dial 10" x 6 $\frac{3}{4}$ ") ... .. **66/-**

### JUNIOR MODEL

8-1 (Dial 6 $\frac{1}{2}$ " x 3 $\frac{1}{2}$ ") ... .. **15/6**

### "R" METERS for AR88

0-1 Amp. Hot wire ... .. **39/6**

0-1 Amp. Thermo Couple ... .. **77/6**

### CHASSIS CUTTERS

1 $\frac{1}{8}$ " ... .. **10/6**

1 $\frac{1}{4}$ " ... .. **12/6**

813 CERAMIC V BASES ... .. **8/9**

**METAL CABINETS. RACKS.  
CHASSIS AND PANELS, ETC.**

Obtainable from your local "Q MAX" dealer or direct from—

# BERRY'S

(SHORT WAVE) LTD.

25 HIGH HOLBORN, LONDON, W.C.1

(Opposite Chancery Lane)

Telephone: HOLborn 6231

ILLUSTRATED CATALOGUE 6d. POST FREE

Applications for Territorial Dealers invited